



GEA[®]

One Stop Supply Commercial
Refrigeration & Medical
Refrigeration



Display Cooler

Product Catalogue



Kabinet pendingin 'heavy duty' sangat efisien untuk menyimpan aneka minuman kaleng (soft drink), minuman kemasan dan buah-buahan. Dilengkapi lampu interior LED agar produk terlihat jelas dan menarik. Thermostat analog agar mudah mengatur suhu yang diinginkan. Cocok untuk Hotel, Rumah Sakit, Kedai/Kantin, Rumah Tangga, dll.

Features

- Interior LED on top
- Fan cooling system
- Adjustable Shelves & Feet
- Thermostat analog
- Recessed handle
- Double layer temp. glass door
- Pad lock slot



EXPO-50FD BLACK



EXPO-50FD



EXPO-90FD

Features

- Interior lamp on top
- Fan cooling system
- Double layer glass door
- Adjustable Shelves
- Frameless door with lock



EXPO-50CVD



EXPO-90CVD



EXPO-26FR



EXPO-30FR



EXPO-37FR



Features

- Ozone friendly (CFC & HCFC Free)
- LED spot light
- Big fan cooling system
- Anti condensation air blow system
- Roll-bond evaporator
- Self evaporated defrost system
- Double layer glass door (Tempered + Tempered)
- Analog thermostat
- Castor wheel & door lock
- Adjustable shelves

TYPE	DIMENSION (cm)			VOL (L)	WATT (220V/1P)	REFRIG	SHELF (pcs)	WEIGHT (kg) Nett Gross
	L	W	H					
EXPO-50FD BLACK	44,5	51	50,1	52	93	R600a	2	21 / 22
EXPO-50FD	44,5	51	50,1	52	93	R600a	2	21 / 22
EXPO-90FD	44,5	51	83,1	92	95	R600a	4	28,5 / 30
EXPO-50CVD	49,5	45	49,5	45	90	R600a	1	22 / 24,5
EXPO-90CVD	49,5	45	82,5	95	110	R600a	3	32 / 35,5
EXPO-26FR	54	56,5	141,4	207	170	R600a	4	42 / 45
EXPO-30FR	54	56,5	153,4	231	175	R600a	4	44 / 48
EXPO-37FR	54	56,5	171,4	271	180	R600a	5	47 / 51



Kabinet pendingin 'heavy duty' sangat efisien untuk menyimpan aneka minuman kaleng (soft drink), minuman kemasan dan buah-buahan.



- Features
- New door, design M
 - Inverter compressor
 - Thermostat analog
 - LED spot light
 - Fan cooling system
 - Matt black

TYPE	DIMENSION (cm)			VOL (L)	WATT (220V/1P)	REFRIG (gram)	SHELF (pcs)	WEIGHT (kg)	
	L	W	H					Nett	Gross
EXPO-26FRN	54	54,5	141,4	207	160	R600a/45	3	41	44
EXPO-30FRN	54	54,5	153,4	231	170	R600a/45	4	43	47
EXPO-37FRN	54	54,5	171,4	271	180	R600a/50	5	46	50

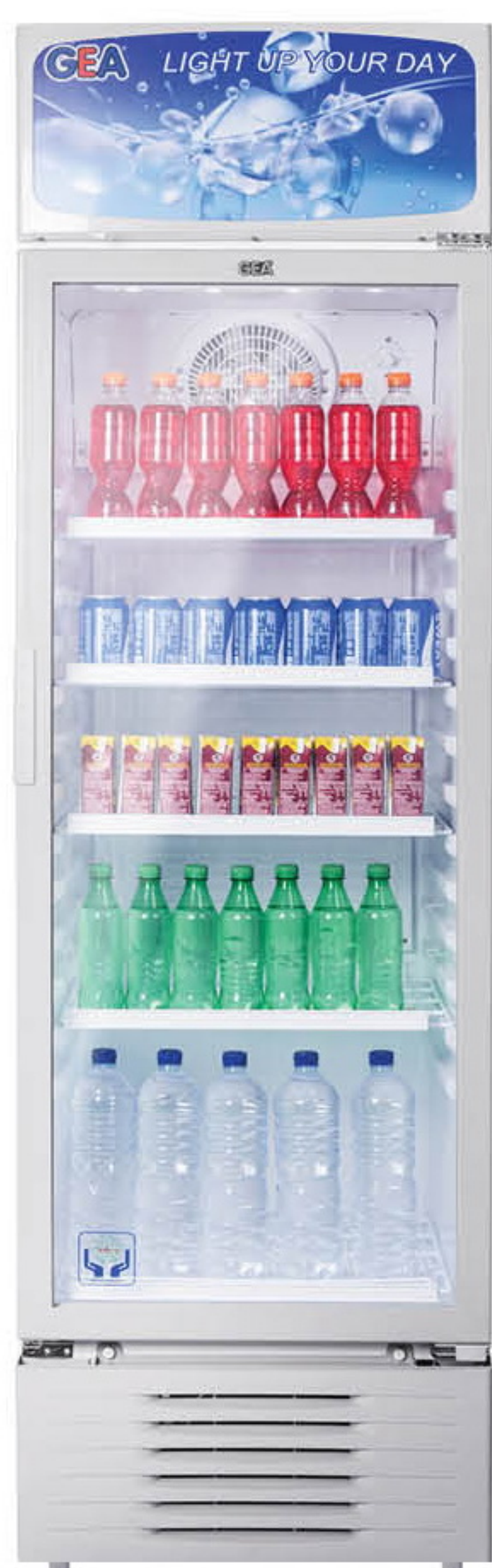

EXPO-382P



- Features
- 2 Layers Tempered Glass
 - Lighted Canopy
 - Fan cooling system
 - Analogue thermostat
 - LED spot light



EXPO-410P



- Features
- 2 Layers Tempered Glass
 - Lighted Canopy
 - Fan cooling system
 - Analogue thermostat
 - LED spot light
 - Castor, adjustable leveling feet

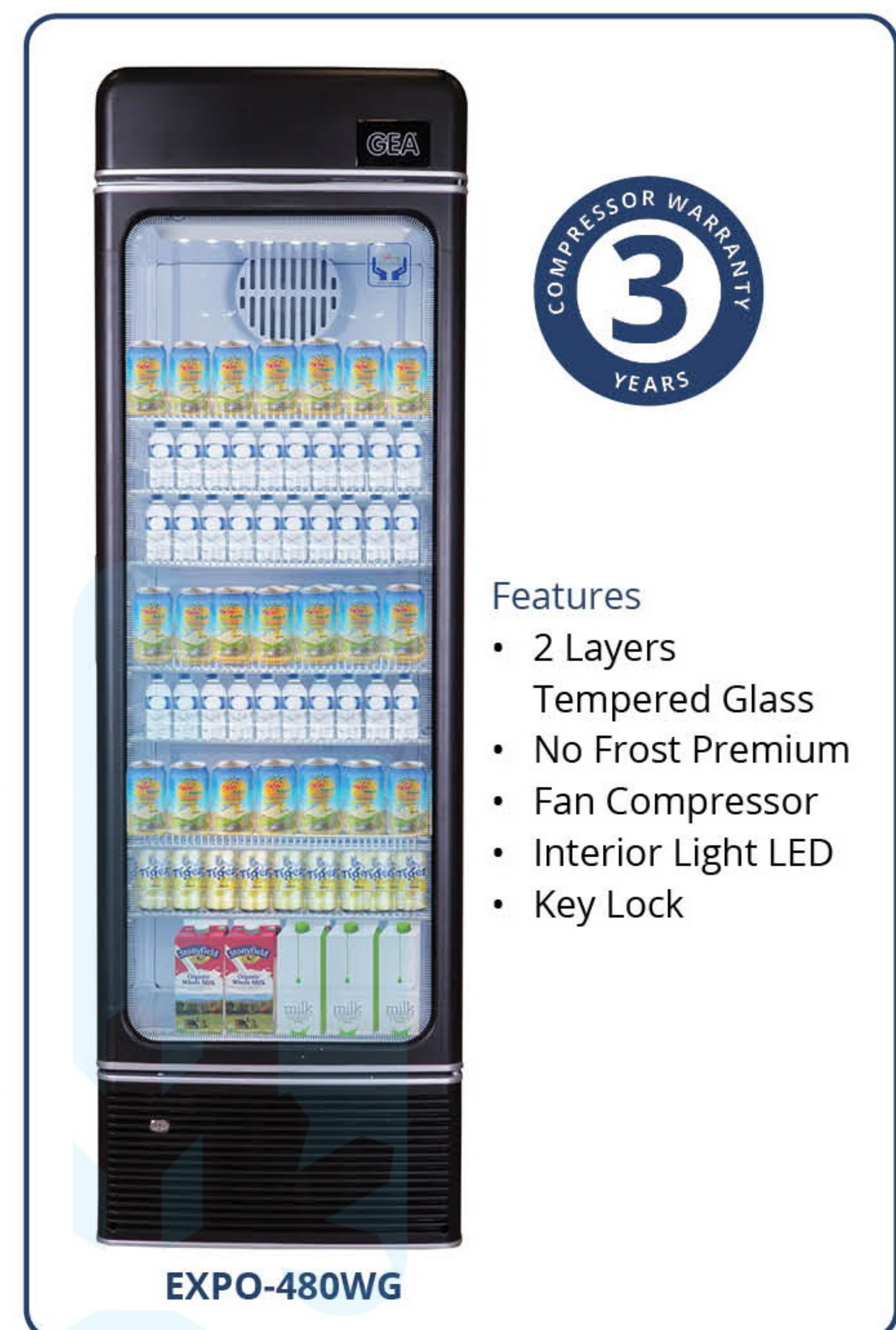

EXPO-480WG



- Features
- 2 Layers Tempered Glass
 - No Frost Premium
 - Fan Compressor
 - Interior Light LED
 - Key Lock

TYPE	DIMENSION (cm)			VOL (L)	WATT (220V/1P)	REFRIG (gram)	SHELF (pcs)	WEIGHT (kg)	
	L	W	H					Nett	Gross
EXPO-382P	60	65	210,6	382	220	R600a	5	83	90
EXPO-410P	66	70	213,5	410	275	R290/75	5	74	79
EXPO-480WG	65,9	71,5	212,1	437	560	R290	7	94	104



EXPO-1000 VFC
Low-E Glass

Features

- Digital thermostat
- Vertical Light
- Castor, wire shelf, price tag
- Fan cooling system
- Compressor : Donper
- Self closing door
- 2 layers glass door with one tempered in Low-e coating
- Metal cover canopy
- Auto evaporation water tray
- Temp. +4 ~ +8°C
- Lock



EXPO-1200 IC
Low-E Glass

Features

- Digital thermostat
- Interior LED light
- 2 layers glass door with 1 layer Low-E glass
- Aluminium door frame
- Lighted Canopy
- Fan cooling system
- 4 pcs castor, 2 with brake
- Temp. +2~+8°C
- Self closing door
- Fan condensor
- Lock

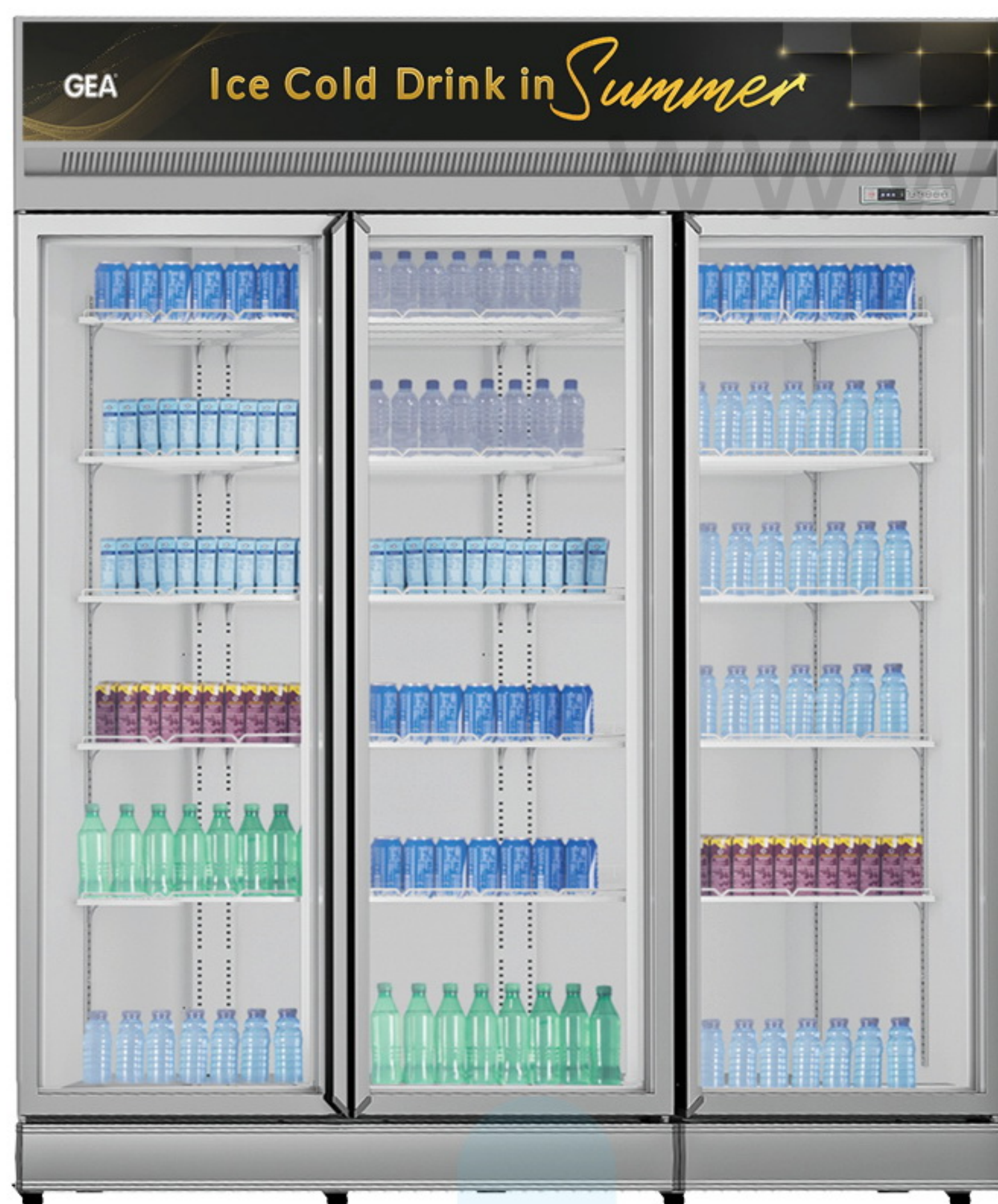

EXPO-1900 IC
Low-E Glass

Features

- Digital thermostat
- 2 layers hollow glass door with one tempered in Low-e coating
- Fan cooling system
- Evap & condensor fan
- 3 vertical LED + canopy light
- Self closing door & lock
- Castor 8 pcs, 4 w/ brake
- Aluminium door frame
- Temp. +2~+8°C



EXPO-2500 IC
Low-E Glass

Features

- Digital thermostat
- 2 layers glass door with one tempered in Low-e coating
- Fan cooling system
- 2 Compressor
- Temp. +2~+8°C
- 4 vertical LED + canopy light
- Castor 8 pcs, 4 w/ brake & lock
- Aluminium door frame & front grill
- Lock

TYPE	DIMENSION (cm)			VOL (l)	WATT (220V/1P)	REFRIG.	SHELF Pcs	WEIGHT (kg) Nett Gross
	L	W	H					
EXPO-1000 VFC	115,5	72,6	209,2	1050	510	R290	14	140 / 150
EXPO-1200 IC	125,3	74	209,2	1195	480	R290	10	178 / 202
EXPO-1900 IC	188	74	209,2	1886	820	R290	15	204 / 220
EXPO-2500 IC	250,8	74	209,2	2488	845	R290	20	355 / 410



Temperature : +4~ +8°C



Kabinet pendingin pintu kaca 'heavy duty' sangat efisien untuk display aneka produk minuman soft drink, minuman kemasan dan buah-buahan. Dilengkapi lampu interior vertikal agar produk terlihat jelas dan menarik. Thermostat digital agar mudah mengatur suhu yang diinginkan. Cocok untuk Hotel, Rumah Sakit, Kedai/Kantin, Restoran, Minimarket, Toko buah, dll



Features

- Interior LED light
- 2 layers Low-E glass
- Flat lighted canopy
- Refrigerant R290
- Sturdy aluminium door frame
- Lock & Castor

TYPE	DIMENSION (cm)			VOL (l)	WATT (220V/1P)	REFRIG.	SHELF	WEIGHT (kg)	
	L	W	H					Nett	Gross
EXPO-600AH/CN	95	63	190	575	405	R290	8	110	113
EXPO-800AH/CN	106,2	68	200	800	512	R290	10	132	135
EXPO-1050AH/CN	121	68	218	1050	546	R290	10	157	160
EXPO-1300AH/CN	160	68	200	1300	751	R290	15	194	197
EXPO-1500AH/CN	170,2	68	218	1500	785	R290	15	207	210



Temperature : +2 ~ +8°C



EXPO-770 IC Black



EXPO-1180 IC Black

Features

- Digital thermostat
- Internal LED spot light
- 2 layers hollow glass door with 1 Low-E
- Fan cooling system
- Interior-exterior black body painted steel
- Compressor : Donper
- Door handle : full length plastic
- Adjustable shelf
- Plastic door frame
- Canopy : flat metal
- Lock, castor wheel with break

TYPE	DIMENSION (cm)			VOL (L)	WATT (220V/1P)	REFRIG.	SHELF Pcs	WEIGHT (kg) Nett Gross
	L	W	H					
EXPO-770 IC Black	110	59,6	200,3	770	405	R290	10	107 / 115
EXPO-1180 IC Black	165	59,6	200,3	1180	580		15	156 / 167

www.balicoolers.com

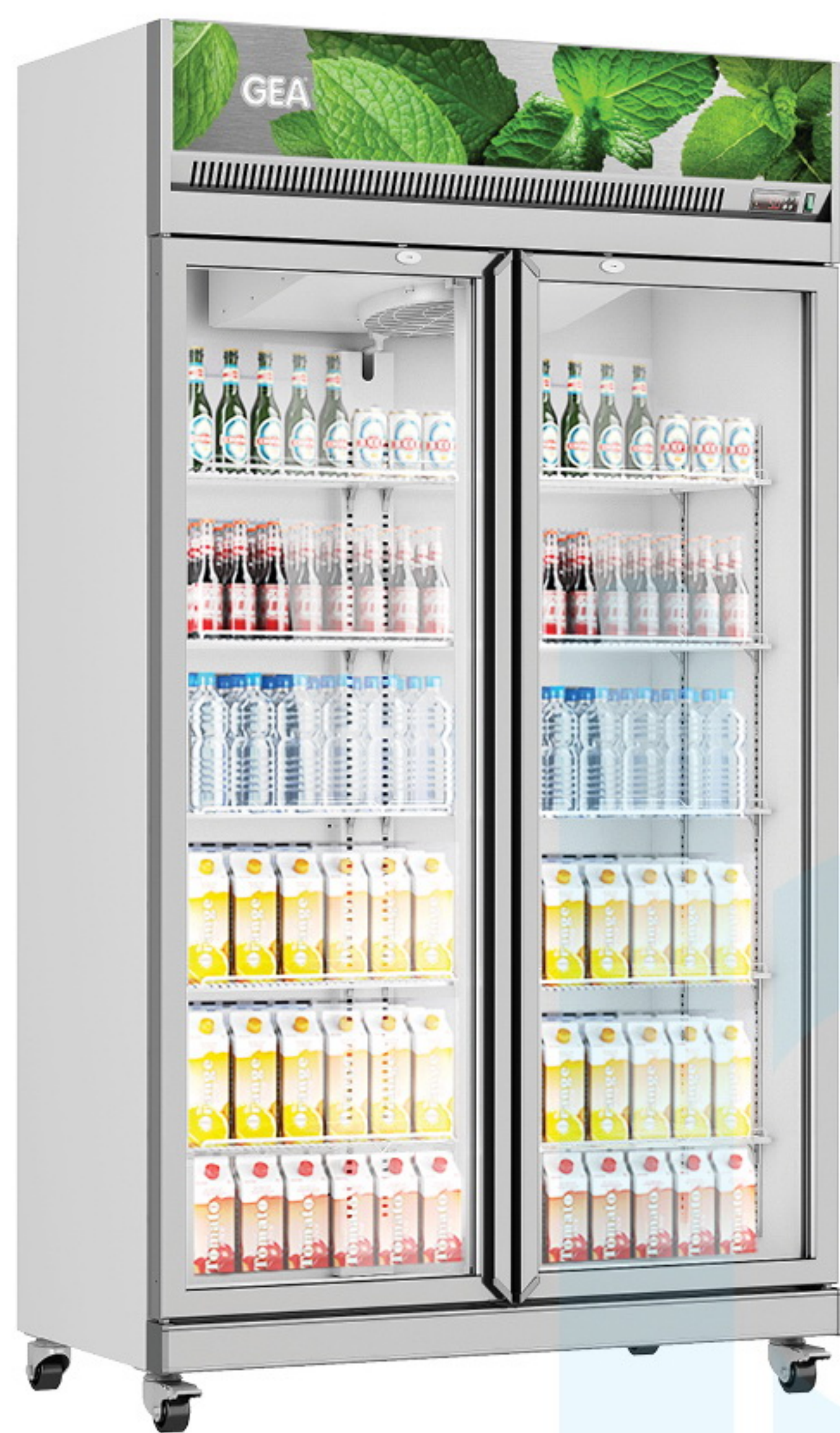

EXPO 770 IC White



EXPO 1180 IC White

Features

- Digital thermostat
- Internal LED spot light
- 2 layers hollow glass door with 1 Low-E
- Fan cooling system
- Interior-exterior white body painted steel
- Compressor : Donper
- Door handle : full length aluminium
- Adjustable shelf
- Aluminium door frame
- Canopy : flat metal
- Lock, castor wheel with break

TYPE	DIMENSION (cm)			VOL (L)	WATT (220V/1P)	REFRIG.	SHELF Pcs	WEIGHT (kg) Nett Gross
	L	W	H					
EXPO-770 IC White	110	59,6	200,3	770	405	R290	10	107 / 115
EXPO-1180 IC White	165	59,6	200,3	1180	580		15	156 / 167

Wine Cooler

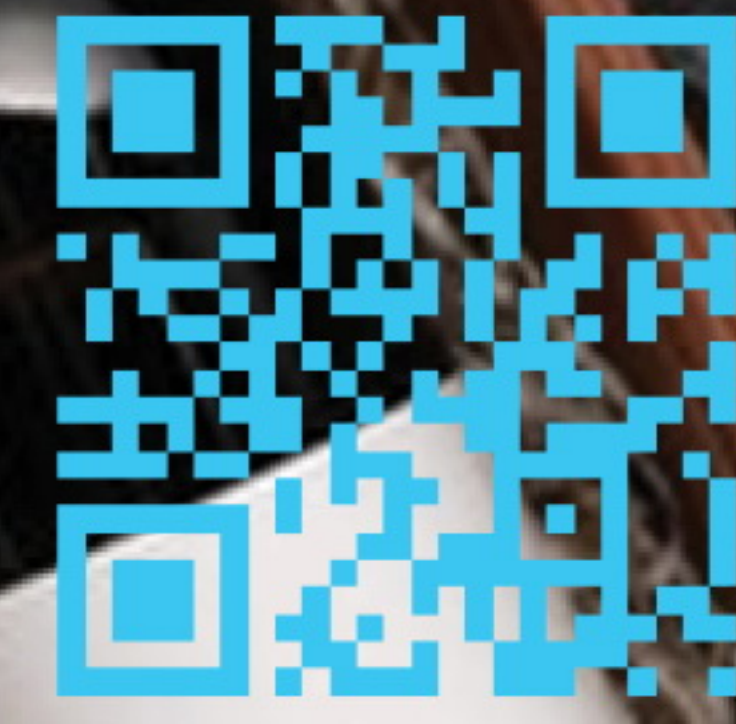

SINGLE ZONE TEMPERATURE



XW-85FD

Features

- Frameless door
- LED light
- Lock
- Adjustable feet
- Low noise
- Energy saving
- Wooden shelves



SC-100R
DIGITAL TEMP.DISPLAY

Features

- Digital thermostat with digital temp. display
- Low-E tempered glass
- LED interior light
- Low noise
- Wooden shelves

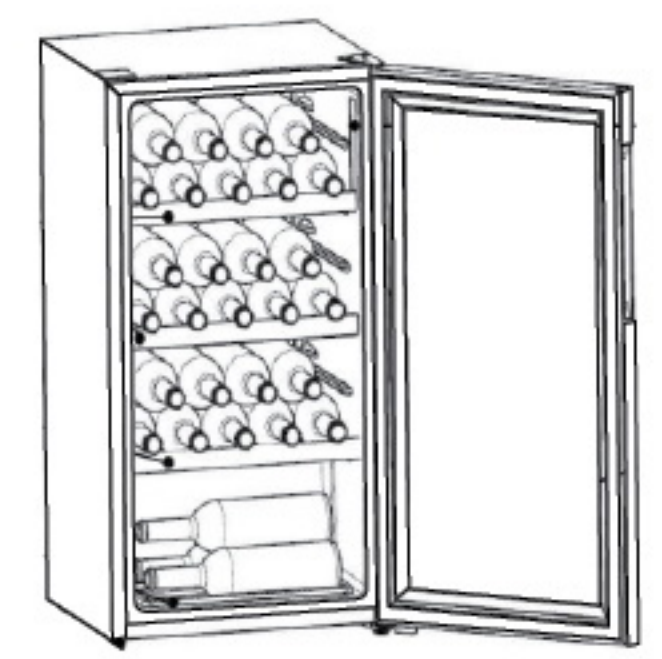

Bottle capacity:
30 pcs (*)

(*) Kapasitas muat botol wine yang tertera berdasar standar botol wine BORDEAUX kapasitas 750ml

www.balicoolers.com

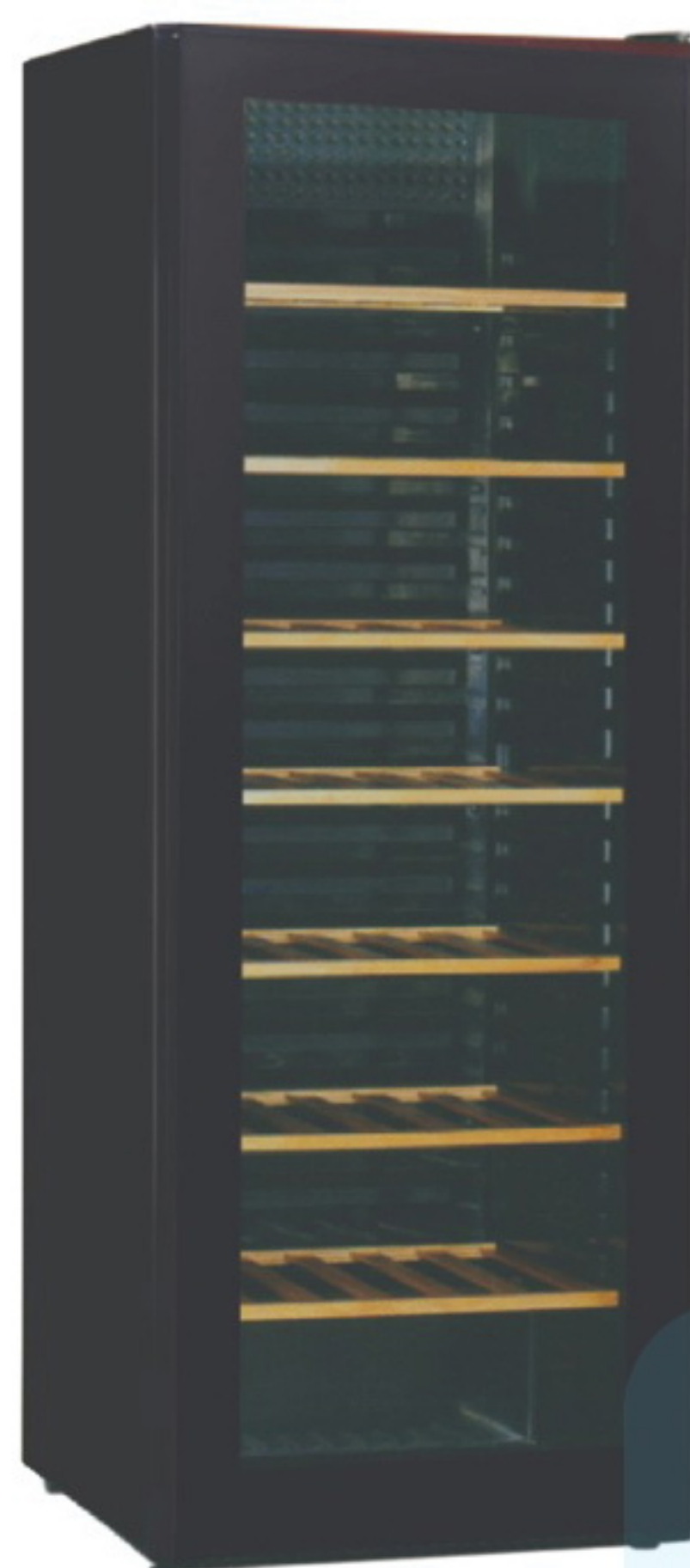

XW-400FD
DIGITAL TEMP.DISPLAY

Features

- LED light
- Digital thermostat
- Adjustable feet



RT-400L
DIGITAL TEMP.DISPLAY
Curved glass door

Features

- Curved glass door
- Internal LED light on side
- Digital temperature controller & display
- Cooling system on top
- Wine shelf
- 4 sides triple glass
- 4 castors, 2 with brake
- Ventilated cooling system
- Automatic defrost

TYPE	DIMENSION (cm)			VOL (L)	WATT (220V/1P)	REFRIG.	BOTTLE	TEMP. (°C)	SHELF (Pcs)	WEIGHT (kg) Nett Gross
	L	W	H							
XW-85FD	44,5	51	67,6	85	82	R600a	18 pcs	+6 ~ +14	3	24 / 27
SC-100R	47,5	44,8	84,5	94	72	R600a	30 pcs	+5 ~ +20	3+1	25 / 26,5
XW-400FD	60	62,7	183,5	342	160	R134a	83 pcs	+6 ~ +14	7	72 / 80
RT-400L	65,6	65,6	189,2	410	500	R290	81 pcs	+5 ~ +18	9	181 / 204

www.balicoolers.com



Features

- Ideal for long term storage
- Black lacquered steel
- Tinted glass door with UV-filter
- Lockable door
- 6x height adjustable wooden shelves
- Interior light
- Carbonfilter
- Frost protection with built-in heater
- Reversible door
- Adjustable feet
- Dual temperature zones
- Easy-to-adjust thermostat
- Digital temperature display
- Fan assisted cooling
- Low or high temperature alarm
- Low vibration compressor

DIMENSION (L x W x H) (cm)	59,5 x 59,5 x 185
VOLUME (l)	365
CAPACITY (bottles)	113
WATT (220V/1P)	170
WOODEN SHELF (pcs)	6
CHARCOAL FILTER	YES
REFRIGERANT	R600a
WEIGHT	70



W-185

Flower Showcase

Display chiller yang dirancang khusus untuk memajang bunga segar dengan kelembapan 70~80% agar bunga dapat bertahan lebih lama. Dibalut dengan desain kabinet berwarna hitam dan dilengkapi lampu khusus "AGRO" yang menjadikan tampilan bunga lebih segar dan kontras.

Features

- Interior LED light
- Aluminium door frame
- Adjustable shelf
- Lighted canopy
- Auto-close door



EXPO-1050F

EXPO-1500F

TYPE	DIMENSION (cm)			VOLUME (L)	WATT (220V/1P)	TEMP.	WEIGHT (kg) Nett Gross
	L	W	H				
EXPO-1050F	121	68	218	1172	550	+8 ~ +15°C	175 / 178
EXPO-1500F	170,5	68	218	1793	750	+8 ~ +15°C	235 / 238



Kabinet display dengan fitur thermostat digital yang dirancang khusus untuk mendinginkan minuman bersoda dan beralkohol, dengan temperatur -2~-6°C yang menghasilkan frost beverage saat produk dituangkan ke dalam gelas.



Features

- Heated glass door for condensation
- Digital thermostat
- Lighted canopy
- Lock

Gelas harus disimpan di Freezer terlebih dahulu



EXPO-500BC



EXPO-1050BC



EXPO-1500BC

TYPE	DIMENSION (cm)			VOL. (L)	WATT (220V/1P)	SHELF	WEIGHT (kg)		REFR.
	L	W	H				Nett	Gross	
EXPO-500BC	67,5	70	215	420	744	5	120 / 126	R404a	
EXPO-1050BC	121	68	218	1050	861	10	160 / 163	R404a	
EXPO-1500BC	170,5	68	218	1500	962	15	180 / 183	R404a	



Display Cooler with LCD 49"



USS-691DTKL-LCD

Features

- Interior LED light
- Aluminium door frame
- Adjustable shelf
- Lighted canopy
- Auto-close door
- Mini active speaker
- Remote control
- Adjustable feet
- Castor stopper
- Auto-switch fan
- MP4 audio-video file format
- 49" LCD display
- Digital thermostat
- Anti-dew system
- 2 layers glass door
- USB + MMC input device

Display chiller LCD TV GEA generasi terbaru, dirancang khusus untuk display produk minuman komersial sekaligus sebagai media iklan yang efektif. Dilengkapi dengan fitur pintu kaca dua lapis layar LCD 49" yang dapat menampilkan konten promosi sesuai kebutuhan Anda.

DIMENSION (L x W x H) (cm)	78 x 70,5 x 208
VOLUME (l)	495
CAPACITY shelf	5
TEMP (°C)	+2 ~ +8°C
WATT (220V/1P)	
Chiller	485 W
Lamp	165 W
BOTTLES (500 ml)	490
WEIGHT (kg)	123

www.balicoolers.com

Cold Showcase

Display chiller yang memiliki kaca pada empat sisinya dengan lampu interior, sehingga produk minuman (soft drink) yang dipajang akan terlihat jelas dan menarik.



RT-68L-3



RT-98L-3

Features

- Internal top LED light
- Digital thermostat
- Adjustable PVC coated shelves
- 4 sides double glass
- Maintenance free condenser
- Fan cooling system
- Automatic defrost
- Anti condensation air blow system

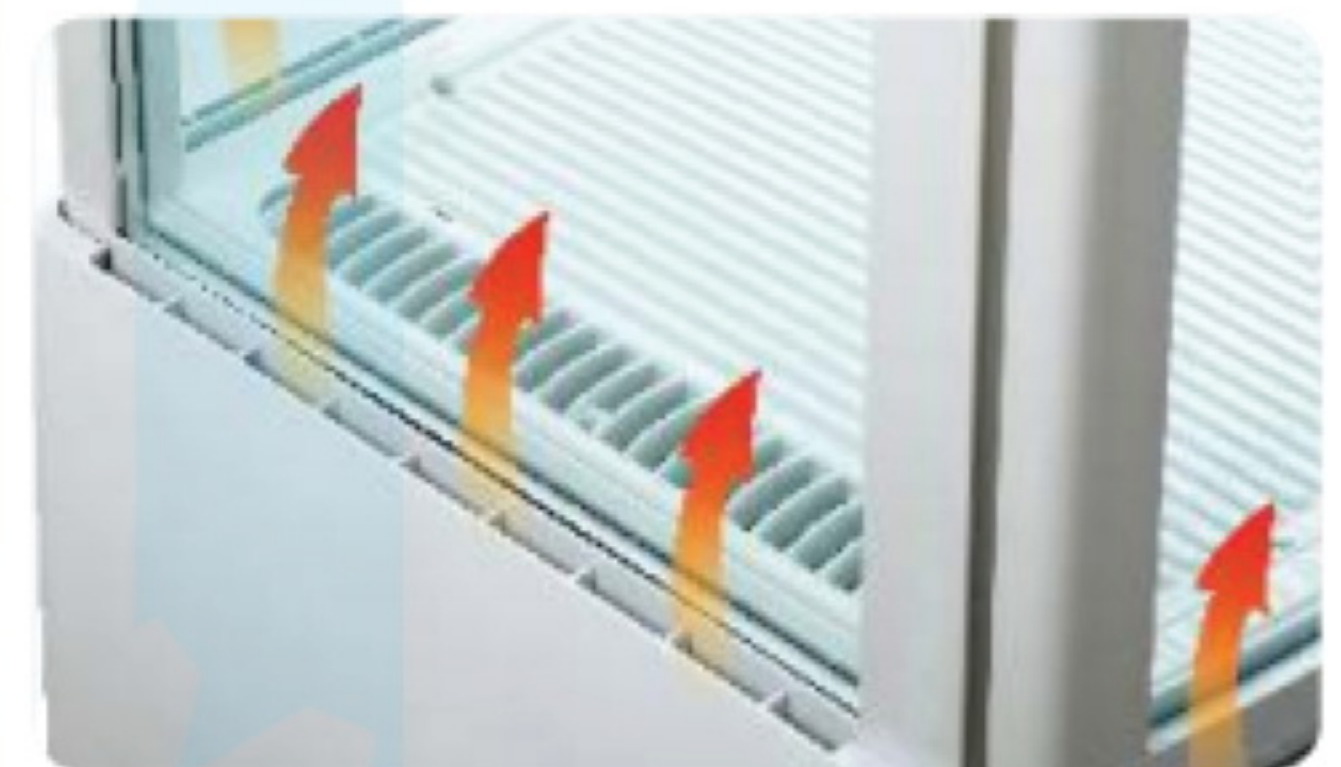

TYPE	DIMENSION (cm)			VOLUME (L)	WATT (220V/1P)	TEMP.	WEIGHT (kg)		REFR.
	L	W	H				Nett	Gross	
RT-68L-3	45,2	40,6	89,1	68	190	0 ~ +12°C	35	37	R134a
RT-98L-3	45,2	40,6	111,6	78	210	0 ~ +12°C	40	42,5	R134a

REFRIGERATED SPIRAL SYSTEM



Spiral system

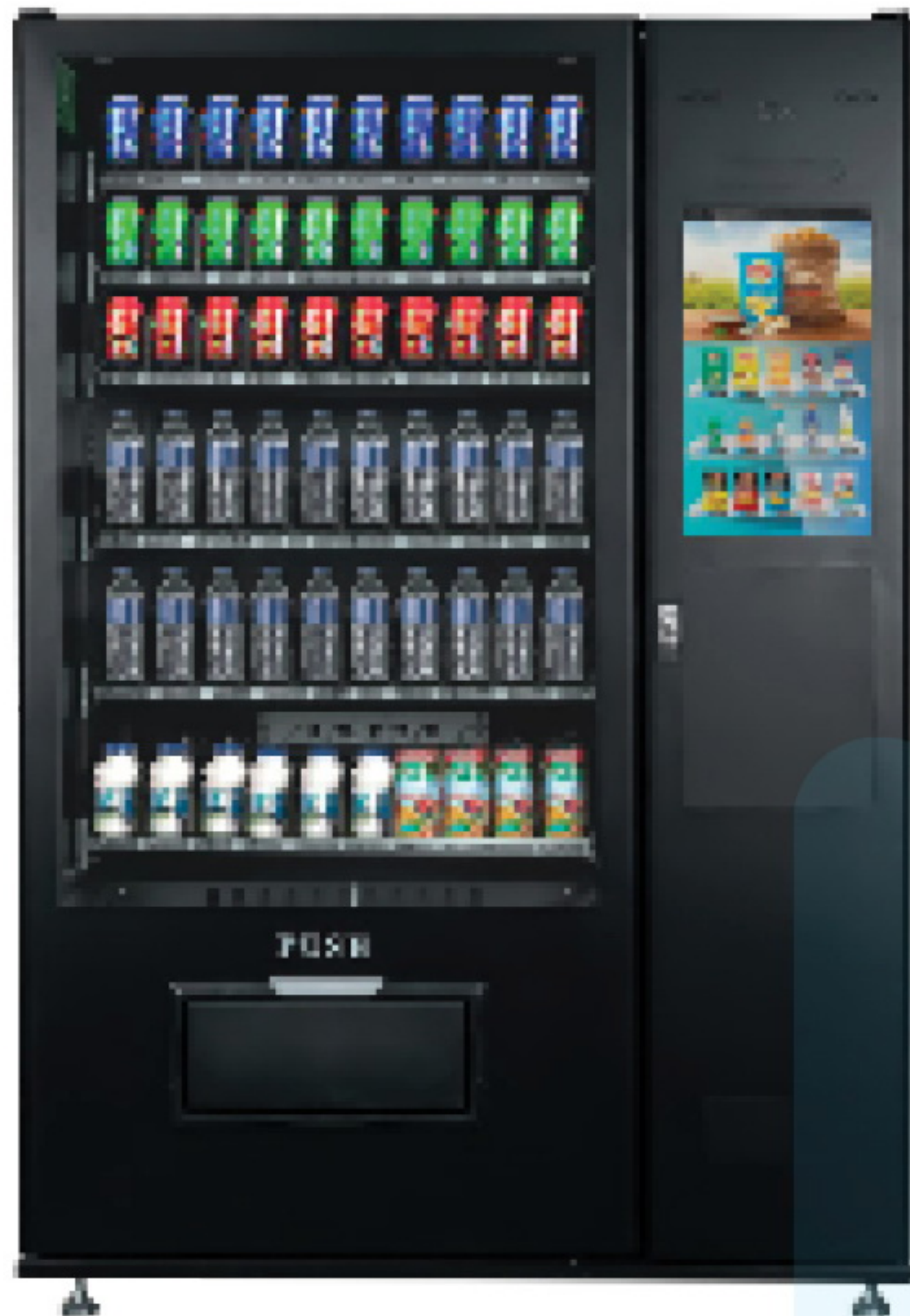

D720-22C(10SP)

Features

- With 22" touch screen
- Android system
- International standard
- With tempered glass, anti-theft collection door
- Standard spiral coil tray

Note:

1 rak = 10 slot, 1 slot = 6 btl (330ml)
Lebar slot: 7,48 | 7,3 | 7,3 | 7,3 | 7,3 | 7,3 | 7,3 | 7,3 | 7,3 | 7,42 cm

Tinggi rak 1, 2, 3 = 13,5 cm
Tinggi rak 4 = 23,5 cm
Tinggi rak 5, 6 = 21,5 cm

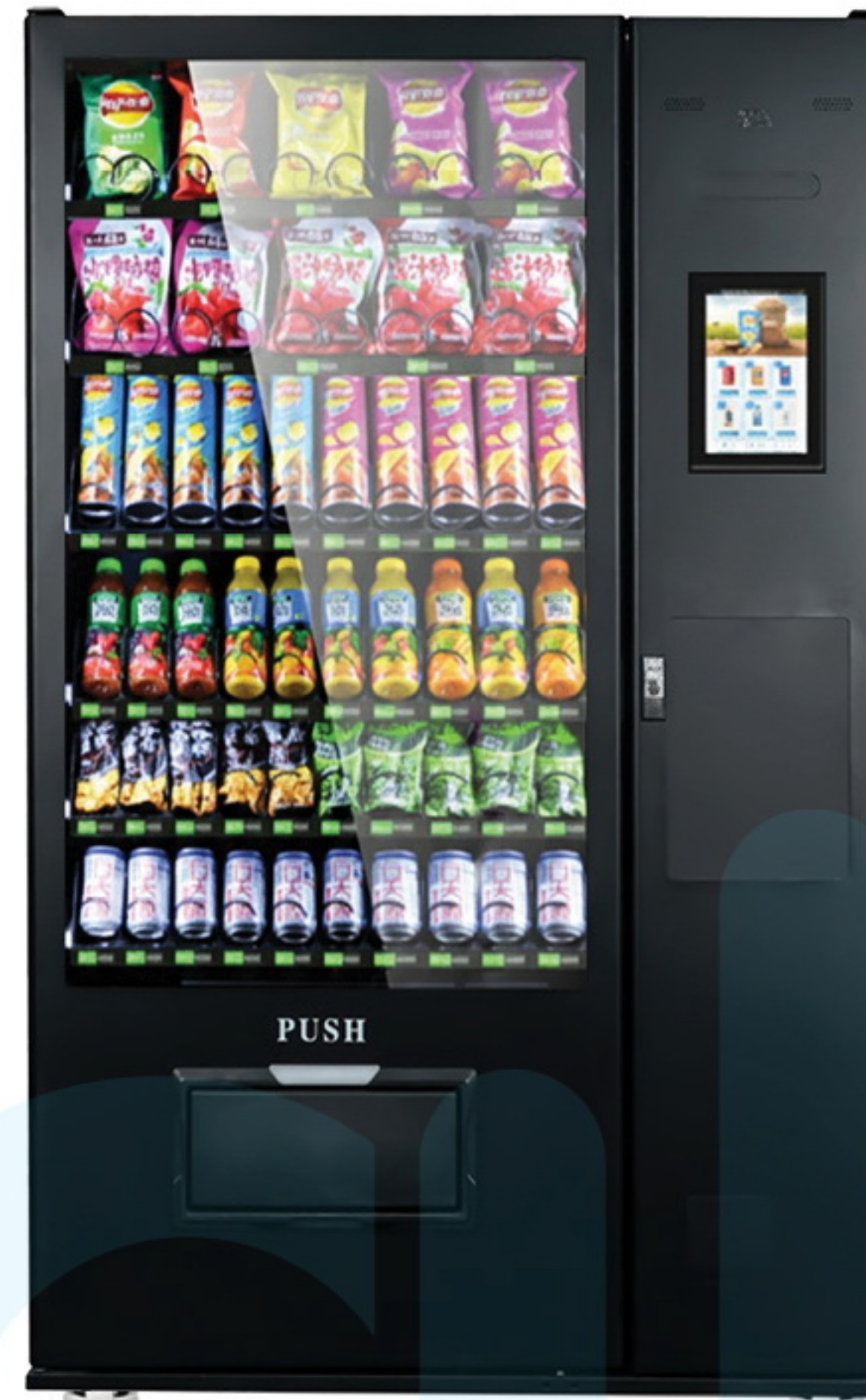

D720-10C(10SP)

Features

- Spiral slots
- 10.1 Inch Touch Screen
- With 4G and Wifi
- Aluminium pricing slot
- Android system
- Payment QRIS, berlaku untuk semua e-payment: Gopay, ShopeePay, Dana, Ovo, BCAMobileBanking, LinkAja, semua aplikasi Mobile Banking dengan fasilitas QRIS

Note:

1 rak = 10 slot, 1 slot 5 botol
Lebar slot: 7,48 | 7,3 | 7,3 | 7,3 | 7,3 | 7,3 | 7,3 | 7,3 | 7,3 | 7,42 cm

Tinggi rak 1, 2, 3 = 13,5 cm
Tinggi rak 4 = 23,5 cm
Tinggi rak 5, 6 = 21,5 cm

TYPE	DIMENSION (cm)			CAPACITY bottle Ø5cm,330ml	WATT (220V/1P)	SHELF (pcs)	REFRIG	WEIGHT (kg)
	L	W	H					
D720-22C(10SP)	135,5	87	194	360 pcs	550	6	R134a	300 / 380
D720-10C(10SP)	116	87	194,5	300 pcs	520	6	R134a	310 / 370

Biaya sewa Cloud Server per tahun

NON-REFRIGERATED SPIRAL SYSTEM



QR Code Standar Pembayaran Nasional



Spiral system

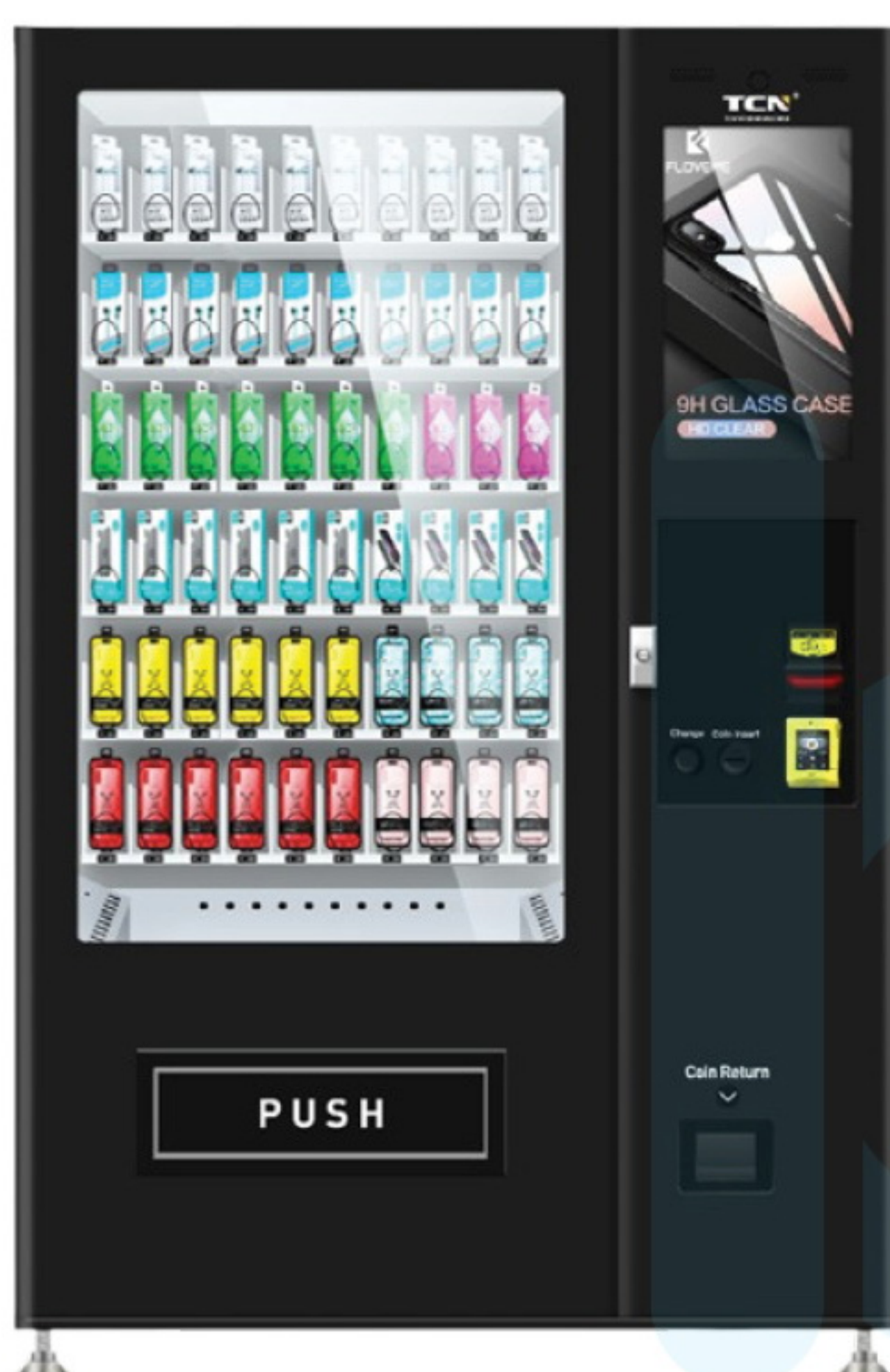

NSC-10C(V22)

Features

- 22" touch screen
- With drop sensor, Android system, 4G and Wifi
- Color: black
- Aluminium pricing slot
- Without cooling system
- Payment QRIS, menerima semua e-payment: Gopay, ShopeePay, Dana, Ovo, BCAMobileBanking, LinkAja, semua aplikasi Mobile Banking dengan fasilitas QRIS

Note:

- 1 rak = 10 slot, 7 pcs
- Lebar slot : 7 cm
- Tinggi rak 1, 3, 4, 5, 6 = 17,5 cm
- Tinggi rak 2 = 19,5 cm
- Interval spiral : 6 cm
- Diameter spiral : Ø 6,6 cm
- Length of each slot is 40 cm

• Lebar slot: 7,48 | 7,3 | 7,3 | 7,3 | 7,3 | 7,3 | 7,3 | 7,3 | 7,3 | 7,42 cm

TYPE	DIMENSION (cm)			CAPACITY bottle Ø5cm,330ml	WATT (220V/1P)	SHELF (pcs)	WEIGHT (kg)
	L	W	H				
NSC-10C(V22)	133	77	194	350~420 pcs(*)	100	6	240 / 300

Biaya sewa Cloud Server per tahun



REFRIGERATED SPIRAL SYSTEM

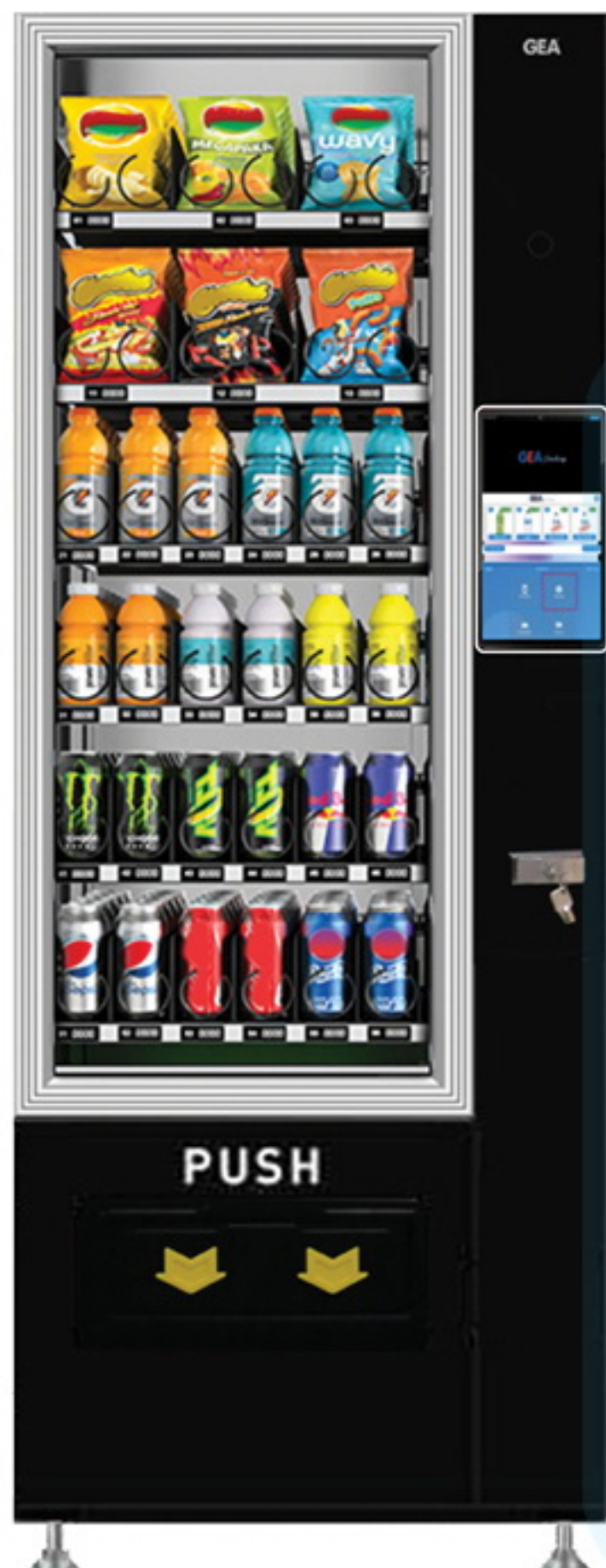

CSC-6G(H5)

- Features
- With 10" touch screen
 - Android system (4G) + Wifi
 - With spiral grooves for delivery
 - With advanced drop sensor
 - International standard
 - With tempered glass, anti-theft collection door

- Note:
- 1 rak = 6 slot, 1 slot = 5 btl (330ml)
 - Lebar slot: 7,47 | 7,3 | 7,3 | 7,3 | 7,3 | 7,47 cm
 - Tinggi rak 1 = 13,5 cm
 - Tinggi rak 2, 4 = 17,5 cm
 - Tinggi rak 3 = 15,5 cm
 - Tinggi rak 5, 6 = 21,5 cm

The length of each slot is 45 cm



Spiral system

TYPE	DIMENSION (cm)			CAPACITY bottle Ø5cm,330ml	WATT (220V/1P)	SHELF (pcs)	REFRIG	WEIGHT (kg)
	L	W	H					
CSC-6G(H5)	73,2	79	193,3	216 pcs	420	6	R134a	240 / 300

Biaya sewa Cloud Server per tahun

REFRIGERATED CONVEYOR SYSTEM



QR Code Standar
Pembayaran Nasional

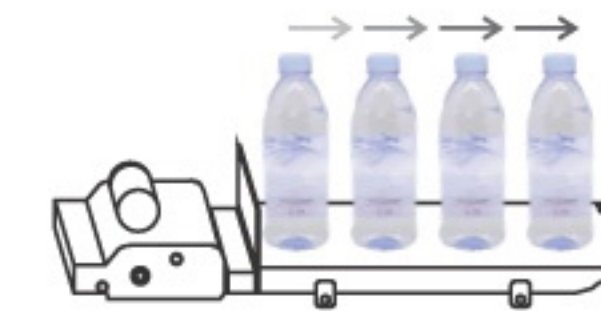

Conveyor slots

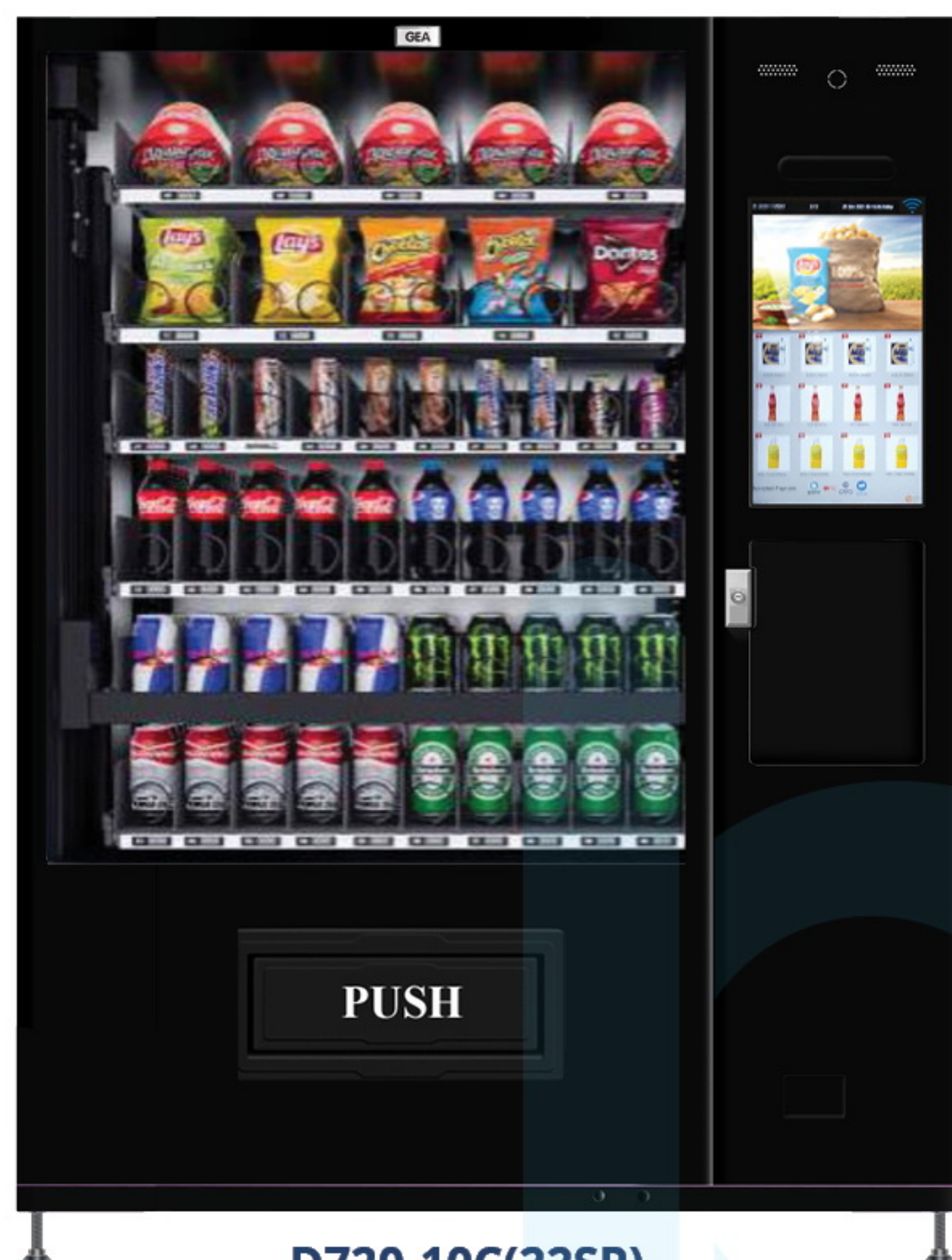

D720-10C(22SP)

- Features
- Conveyor slots
 - 22 Inch Touch Screen
 - With 4G and Wifi
 - Android system
 - LED light

- Note:
- 1 rak = 8 slot, 1 slot = 5 btl (330ml)
 - Panjang @slot = 40cm,
 - Lebar slot: 9,7 | 8,85 | 8,85 | 8,85 | 8,85 | 8,85 | 8,85 | 9,7 cm
 - Tinggi rak 1, 2, 3, 4, 5 = 21,5 cm

- Payment QRIS, berlaku untuk semua e-payment: Gopay, ShopeePay, Dana, Ovo, BCAMobileBanking, LinkAja, semua aplikasi Mobile Banking dengan fasilitas QRIS
- LED light

TYPE	DIMENSION (cm)			CAPACITY bottle Ø5cm,330ml	WATT (220V/1P)	SHELF (pcs)	REFRIG	WEIGHT (kg)
	L	W	H					
D720-10C(22SP)	135,5	85	194	200 pcs	580	5	R134a	370 / 420

Biaya sewa Cloud Server per tahun

REFRIGERATED

CONVEYOR SYSTEM



CSC-10C

Features

- With cooling function
- Android system support
- With advanced drop sensor
- International standard
- With tempered glass, anti-theft collection door

Note:

1 rak = 8 slot
 1 slot = 5 btl (330ml)
 Lebar slot: 9,7 | 8,85 | 8,85 |
 8,85 | 8,85 | 8,85 | 8,85 | 9,7 cm

SPIRAL SYSTEM



CSC-10S

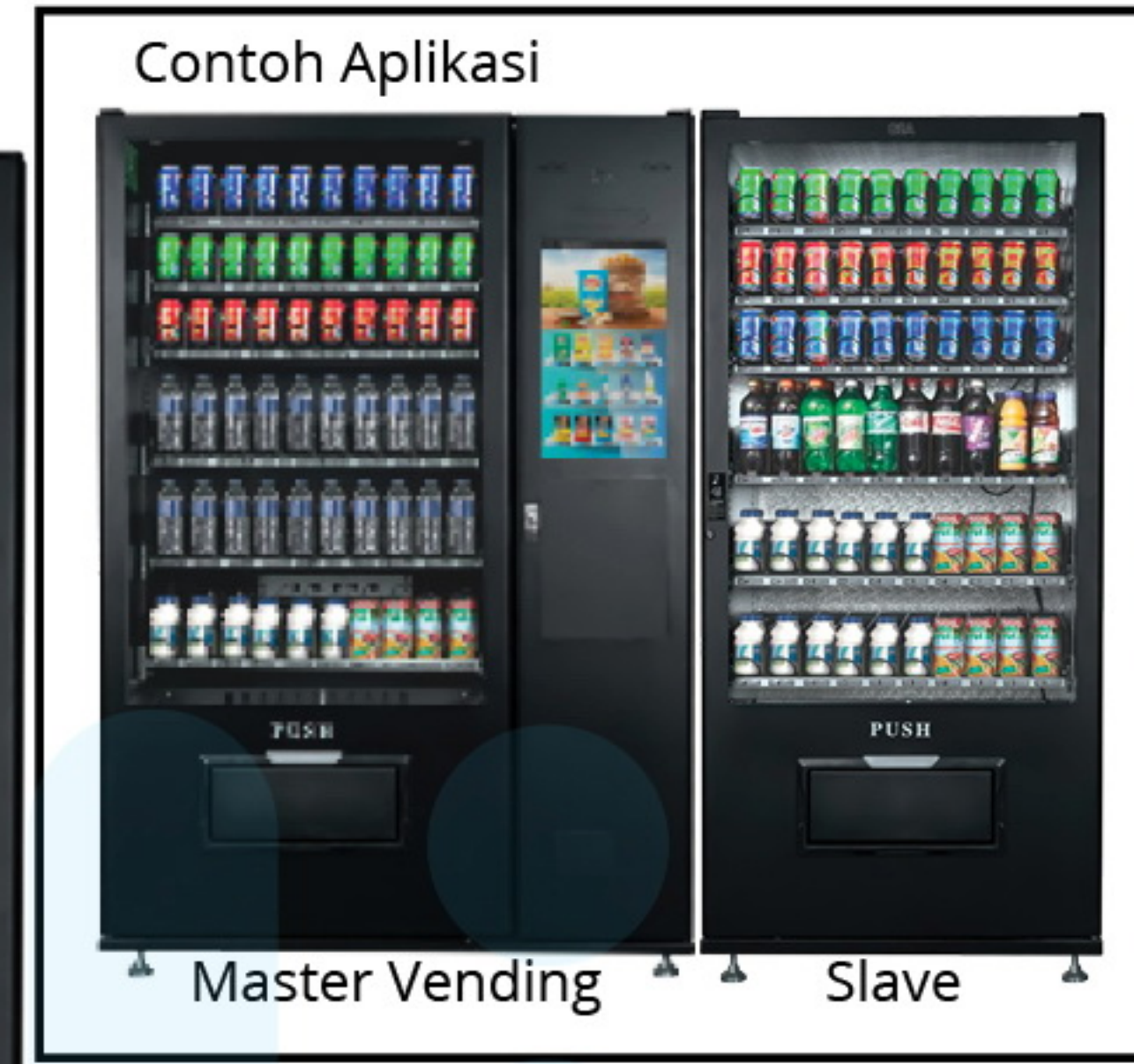

Note:

1 rak = 10 slot, 1 slot = 5 btl (330ml)
 Lebar slot: 7,48 | 7,3 | 7,3 | 7,3 | 7,3 |
 7,3 | 7,3 | 7,3 | 7,3 | 7,42 cm
 Tinggi rak 1, 2, 3, = 13,5 cm
 Tinggi rak 4 = 23,5 cm
 Tinggi rak 5, 6 = 21,5 cm



TYPE	DIMENSION (cm)			CAPACITY bottle Ø5cm,330ml	WATT (220V/1P)	SHELF (pcs)	REFRIG	WEIGHT (kg)
	L	W	H					
CSC-10C	88,2	79	194	300	420	6	R134a	280/340
CSC-10S	88,2	79	194	300	420	6	R134a	280/340

*Note: Mesin vending slave hanya dapat diaplikasikan bersama mesin master vending
 Biaya sewa Cloud Server per tahun

NON REFRIGERATED

CONVEYOR SYSTEM

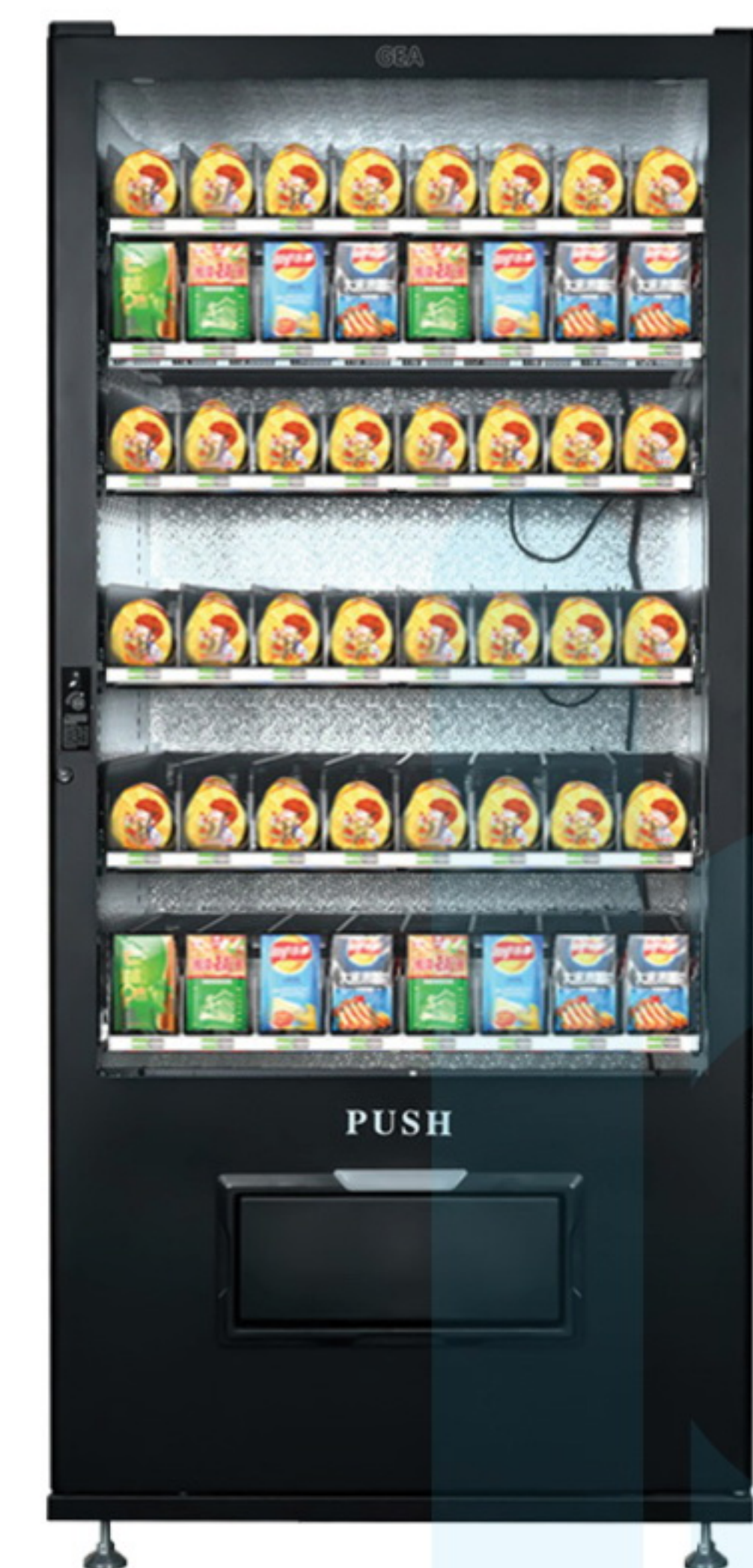

NSC-10C

Features

- Without cooling function
- Android system support
- With advanced drop sensor
- International standard
- With tempered glass, anti-theft collection door

Note:

1 rak = 8 slot, 1 slot = 5 btl (330ml)
 Lebar slot: 9,7 | 8,85 | 8,85 |
 8,85 | 8,85 | 8,85 | 8,85 | 9,7 cm

SPIRAL SYSTEM

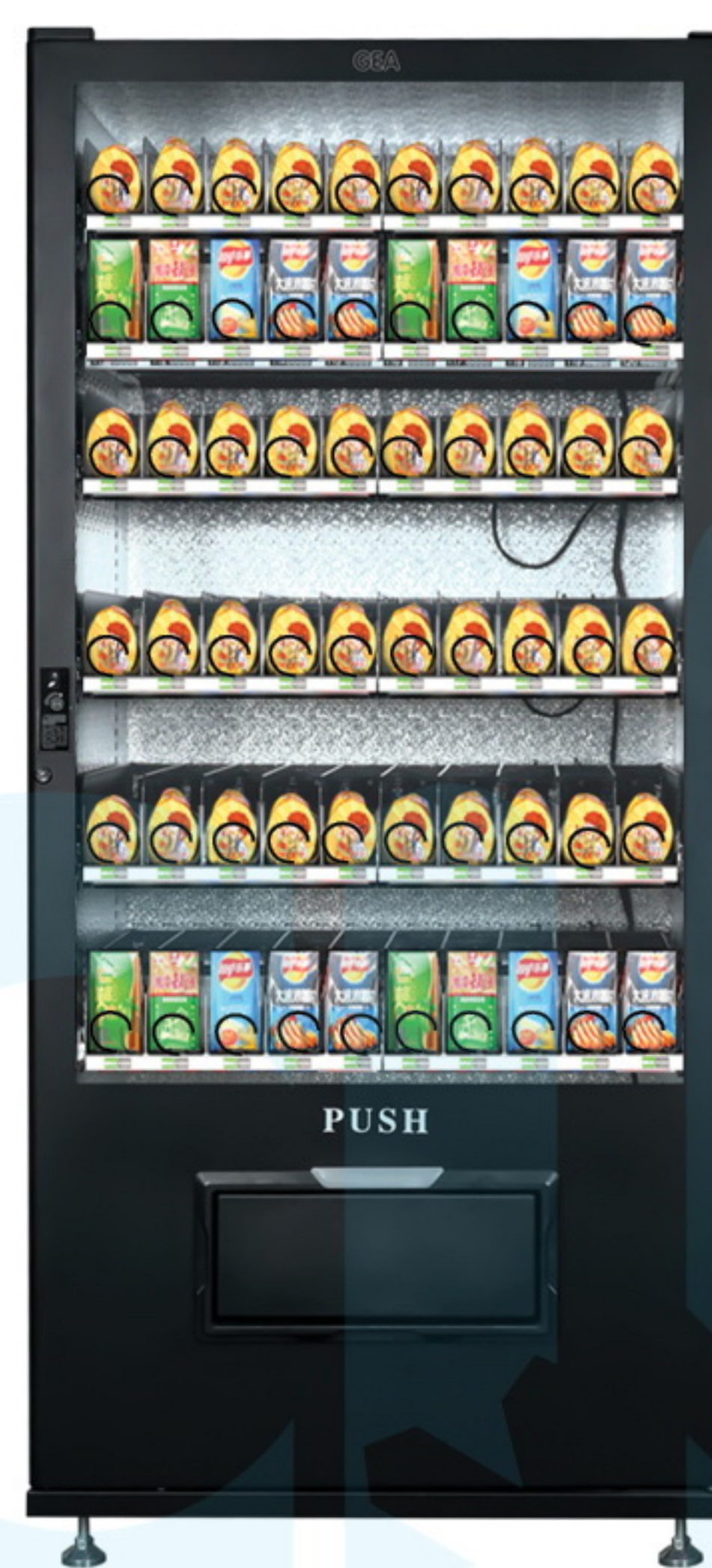

NSC-10S

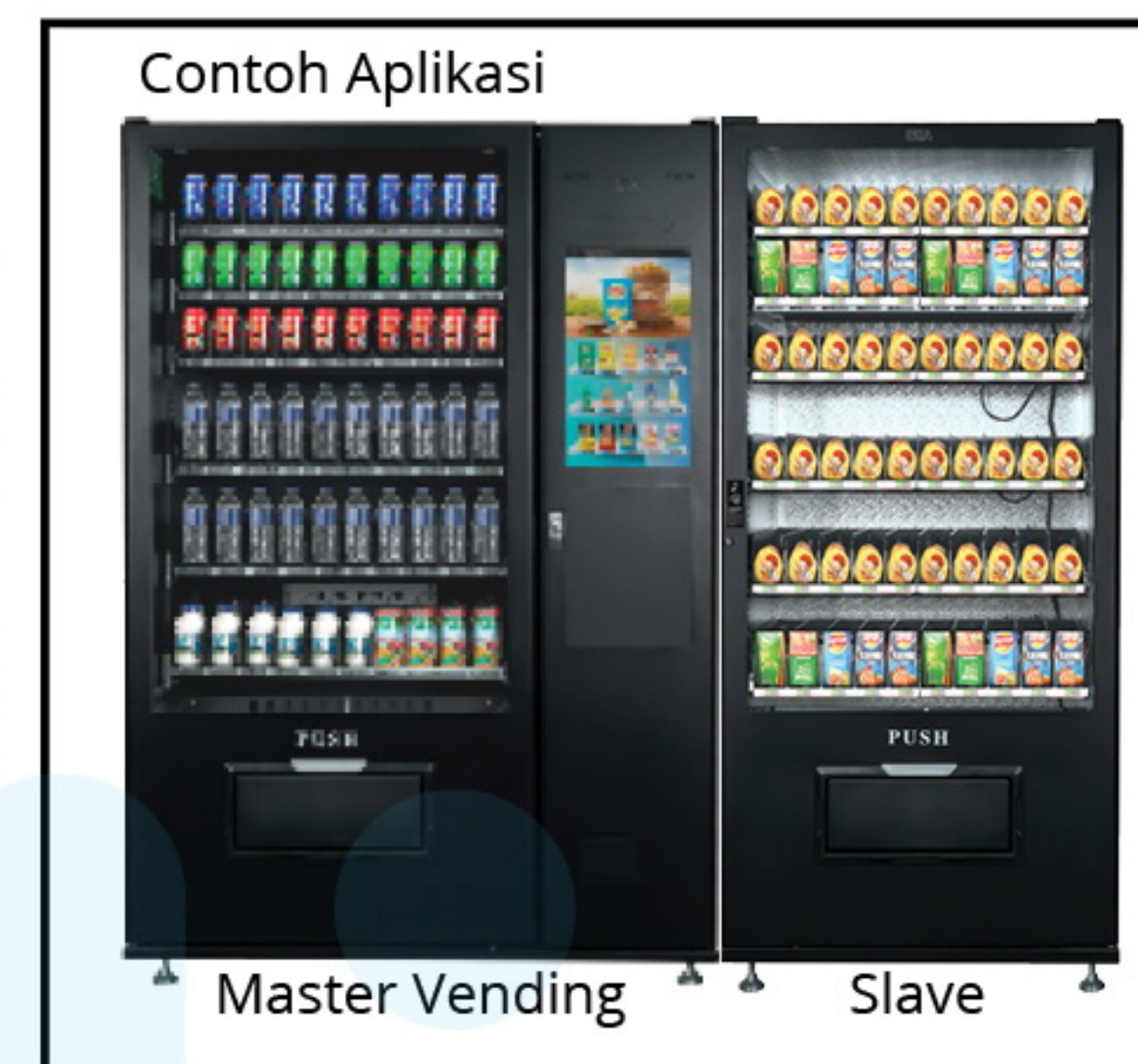

Note:

1 rak = 10 slot, 1 slot = 5 btl (330ml)
 Lebar slot: 7,48 | 7,3 | 7,3 | 7,3 | 7,3 |
 7,3 | 7,3 | 7,3 | 7,3 | 7,42 cm
 Tinggi rak 1, 2, 3, = 13,5 cm
 Tinggi rak 4 = 23,5 cm
 Tinggi rak 5, 6 = 21,5 cm

TYPE	DIMENSION (cm)			CAPACITY bottle Ø5cm,330ml	WATT (220V/1P)	SHELF (pcs)	WEIGHT (kg)
	L	W	H				
NSC-10C	88,2	79	194	300	24	6	260/320
NSC-10S	88,2	79	194	300	42	6	260/320

*Note: Mesin vending slave hanya dapat diaplikasikan bersama mesin master vending
 Biaya sewa Cloud Server per tahun



Counter Top Cake Showcase

Curved glass door

Features

- LED interior light
- Digital thermostat
- 2 adjustable chrome plated shelves
- Double tempered glass
- Front curve glass
- Rear sliding door
- Fan cooling system, auto defrost
- Stainless steel body
- Anti condensation air blow system

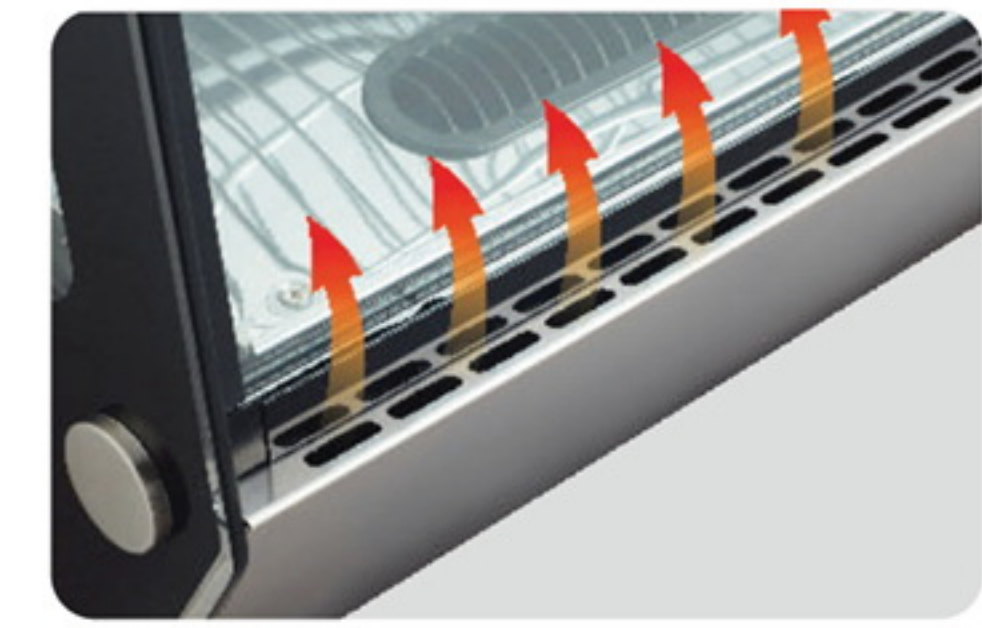

RTW-120L-4CH



RTW-160L-4CH



RTW-202L-4CH



RTW-252L-4CH

TYPE	DIMENSION (cm)			VOLUME (L)	WATT (220V/1P)	REFRIG. (gram)	TEMP. (°C)	WEIGHT (kg) Nett Gross
	L	W	H					
RTW-120L-4CH	70,2	56,8	68,6	120	215	R290 (55)	0 ~ +12	57 / 60
RTW-160L-4CH	88	56,8	68,6	136	240	R290 (60)		66 / 69,5
RTW-202L-4CH	122	56,8	68,6	200	360	R290 (70)		92 / 96
RTW-252L-4CH	152,5	58,8	68,6	227	365	R290 (60)		104,5 / 126

Flat glass door

Features

- LED light
- Automatic defrosting
- Digital thermostat
- Adjustable chrome plated shelves
- Front flat glass
- Rear sliding door
- Fan cooling system
- Maintenance free condenser
- Stainless steel body
- Low energy consumption
- Anti condensation air blow system
- 4 sides double glass

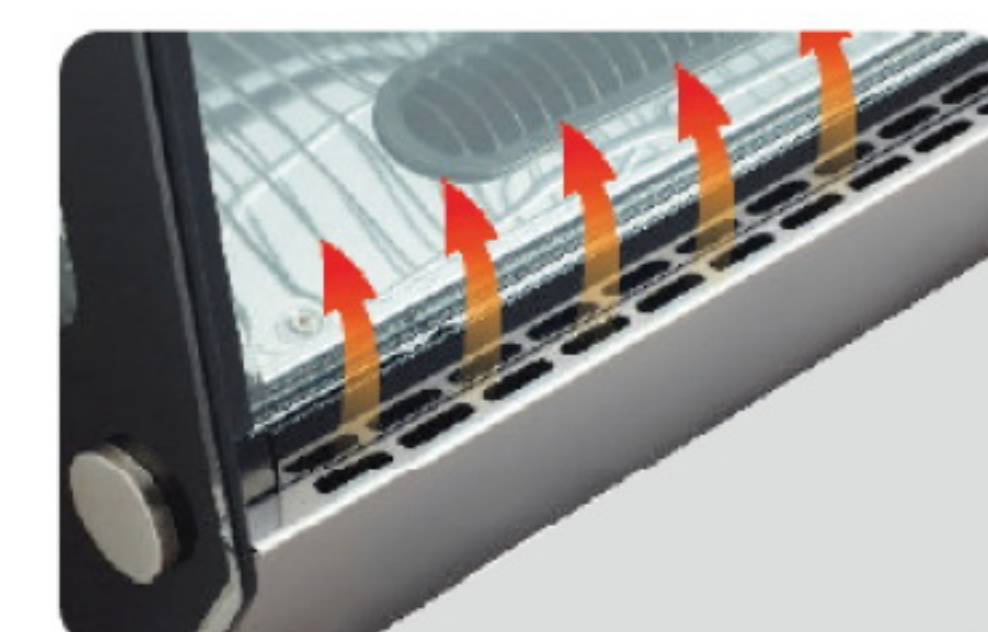

RTW-120L-5



RTW-160L-5



RTW-202L-5



RTW-252L-5

TYPE	DIMENSION (cm)			VOLUME (L)	WATT (220V/1P)	REFRI.	TEMP. (°C)	WEIGHT (kg) Nett Gross
	L	W	H					
RTW-120L-5	70,2	56,8	68,6	120	206	R290	0 ~ +12	57/60
RTW-160L-5	88	56,8	68,6	160	350	R290		66/69,5
RTW-202L-5	121,9	56,8	68,6	200	400	R290		90/94
RTW-252L-5	152,4	56,8	68,6	252	460	R290		116/135



Counter Top Cake Showcase

Cake showcase untuk memajang kue (cake) yang memiliki kaca pada empat sisinya dengan lampu interior, sehingga produk yang dipajang akan terlihat jelas dan menarik. Dilengkapi thermostat digital agar mudah dalam mengatur suhu.



RTW-129L

Features

- LED light
- Digital thermostat
- Sliding back door
- Anti condensation air blow system
- Double tempered glass

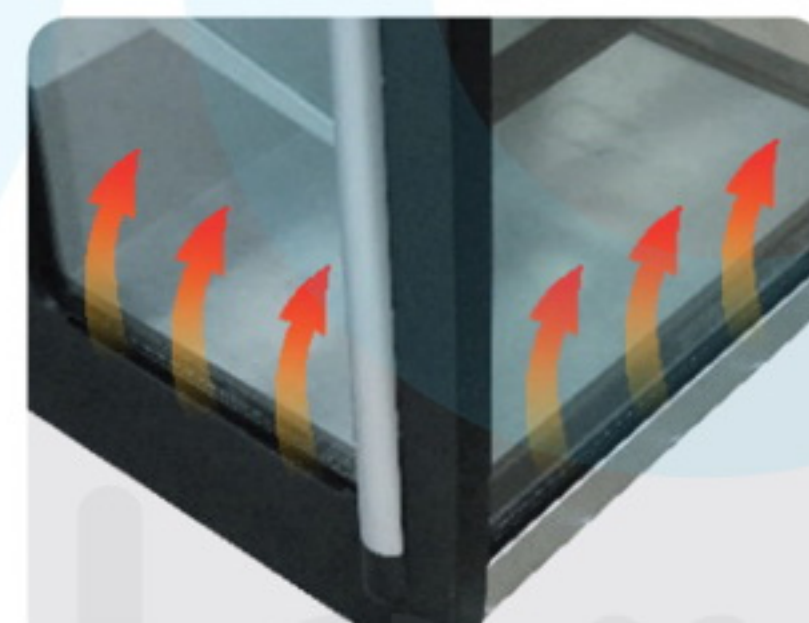

TYPE	DIMENSION (cm)			SHELF (pcs)	VOL. (L)	WATT (220V/1P)	TEMP. (°C)	REFR.	WEIGHT (kg)	
	L	W	H						Nett	Gross
RTW-129L	62,4	56	87,4	3	129	189	+2 ~ +12	R290	58,5	61



RTW-100L-3CH

Features

- Interior LED light
- Digital controller and LED display
- 2 adjustable shelves
- Fan cooling system + automatic defrost
- All sides double-tempered glass
- Body color black



TYPE	DIMENSION (cm)			SHELF (pcs)	VOL. (L)	WATT (220V/1P)	TEMP. (°C)	REFR.	WEIGHT (kg)	
	L	W	H						Nett	Gross
RTW-100L-3CH	68,2	45	67,5	2	100	190	0 ~ +12	R290	39	42,5



Sushi Showcase

Kabinet pendingin dengan pintu kaca lengkung, digunakan untuk memajang sushi agar tampil menarik sekaligus menjaga kualitas sushi. (digunakan untuk display, bukan untuk penyimpanan)

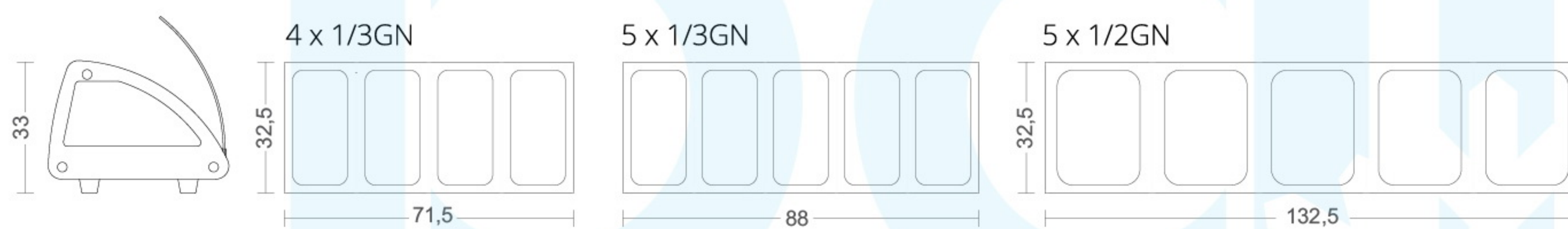

Features

- Internal LED light
- Sliding doors
- Front Curved glass
- Digital thermostat
- Direct cooling system
- Top evaporator with basin to collect condensation
- GN pan included

TYPE	DIMENSION (cm)			VOLUME	WATT (220V/1P)	TEMP. (°C)	REFRIG.	NW / GW (kg)
	L	W	H					
RTS-43L	113,1	45	33	4 x 1/3GN	160 W	+2 ~ +8	R134a	33 / 38
RTS-63L	130,7	45	33	5 x 1/3GN	160 W	+2 ~ +8	R134a	36 / 41
RTS-103L	175,4	45	33	5 x 1/2GN	160 W	+2 ~ +8	R134a	44 / 49

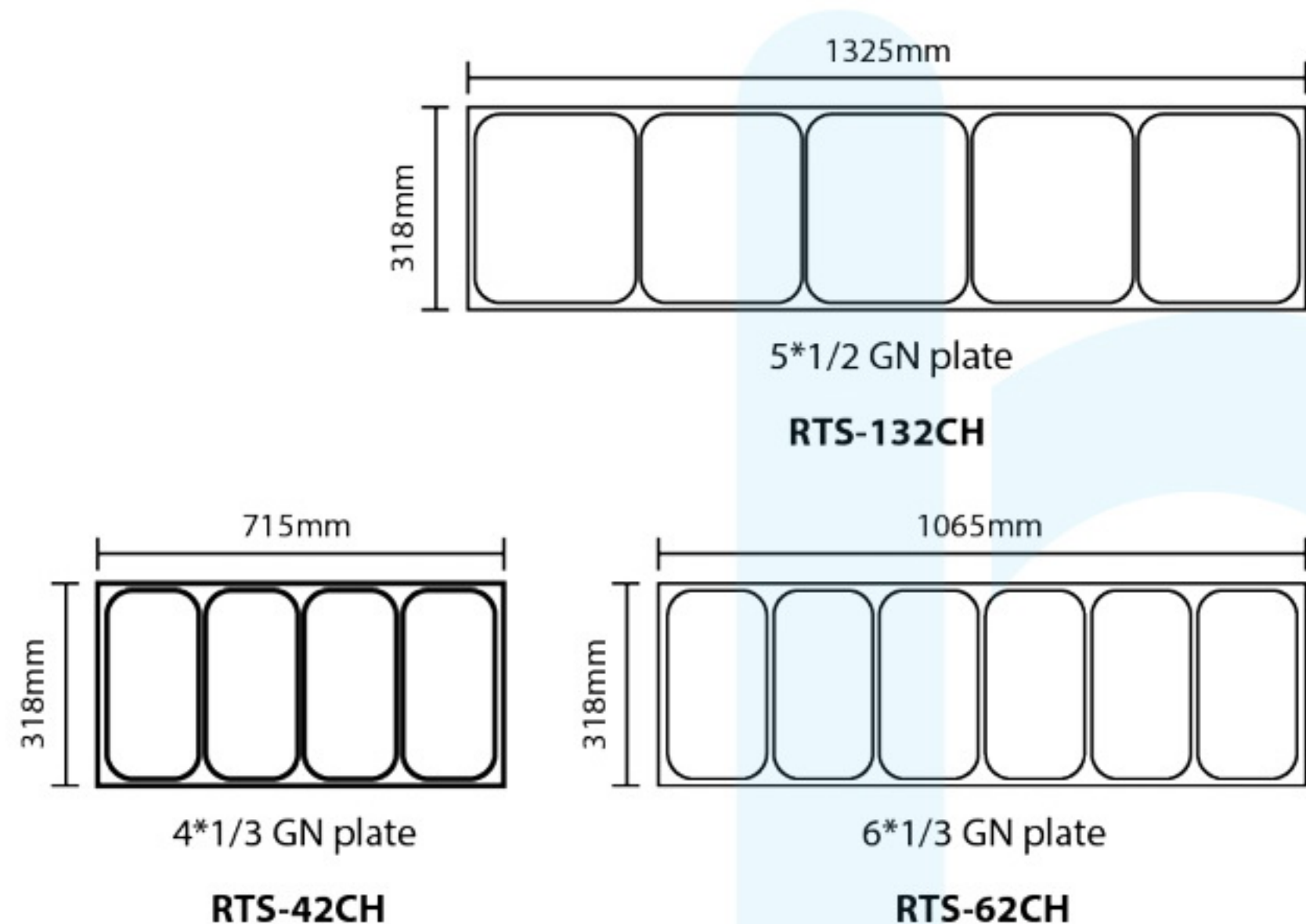

Dimensi P x L
 1/2 GN : 32,5 x 26,5 cm
 1/3 GN : 32,5 x 17,6 cm

Features

- Digital controller & LED interior light
- Direct cooling system + automatic defrost
- Black sliding door tempered glass
- Front and side double-tempered glass
- Color: Black

TYPE	DIMENSION (cm)			VOLUME	WATT (220V/1P)	TEMP. (°C)	REFRIG.	NW / GW (kg)
	L	W	H					
RTS-42CH	117,7	40,6	31,8	31 L (4x1/3GN)	180 W	+2 ~ +12	R290	34,5 / 38,5
RTS-62CH	153	40,6	31,8	45 L (6x1/3GN)	180 W	+2 ~ +12	R290	41,5 / 45,5
RTS-132CH	180	40,6	31,8	59 L (5x1/2GN)	180 W	+2 ~ +12	R290	45 / 49

Sushi Showcase



Sushi Bar dengan sistem pendingin model countertop yang dirancang khusus untuk menampilkan sushi agar menarik sekaligus menjaga kesegarannya pada suhu ideal +4°C hingga +8°C. Unit ini mudah dipasang dan efisien tempat tanpa memerlukan ruang tambahan. Cocok digunakan sebagai display profesional (bukan untuk penyimpanan).



Features

- Countertop design, easy to install and no need extra built-in space
- 2-tone LED lights (warm white or cool white) for clear and attractive food display without glare
- 45° joint glass design for better and modern visual appearance
- Copper pipes on top and bottom for fast & even cooling
- Removable stainless steel shelf for easy cleaning
- Digital temperature controller
- Back sliding doors
- Color: S/s black



SUSHI-R120-P



SUSHI-R150-P



SUSHI-R180-P

TYPE	DIMENSION (cm)			VOLUME (L)	WATT (220V/1P)	TEMP. (°C)	REFRIG.	NW / GW (kg)
	L	W	H					
SUSHI-R120-P	120	35	32,5	36	425	+4 ~ +8	R290	71 / 116
SUSHI-R150-P	150	35	32,5	52	433	+4 ~ +8	R290	91 / 133
SUSHI-R180-P	180	35	32,5	66	441	+4 ~ +8	R290	101 / 151

Drop-In Sushi Showcase

Kabinet display sushi yang memiliki visibilitas dari 3 sisi. Juga tersedia dalam bentuk dan ukuran yang dapat dikustomisasi, serta pemasangan remote condensing unit (special order).

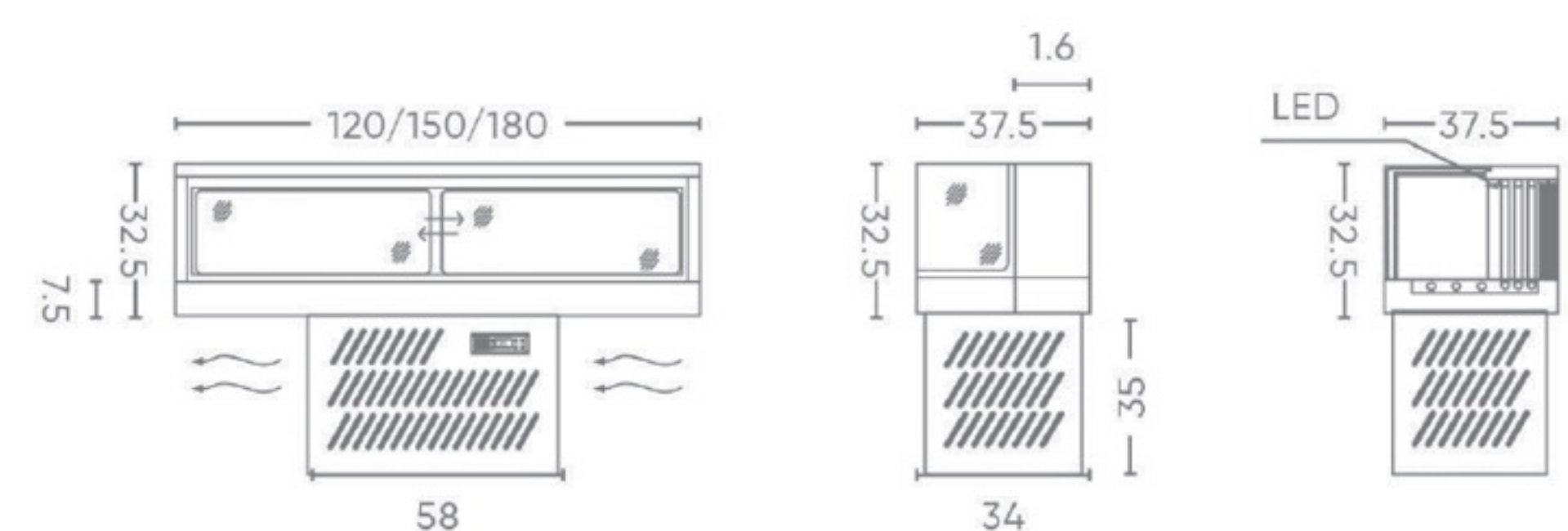

SUSHI-R120-S

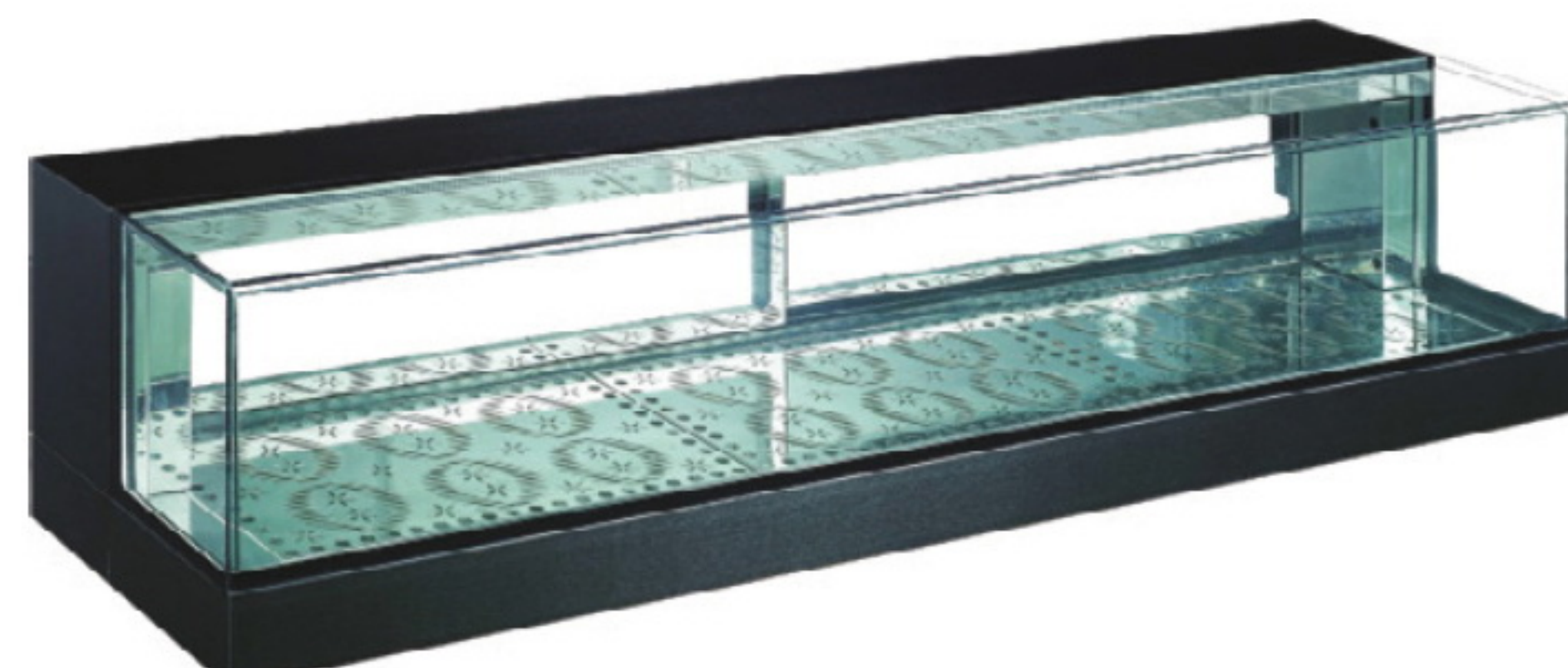

SUSHI-R150-S / SUSHI-R180-S

TYPE	DIMENSION (cm)			VOLUME (L)	WATT (220V/1P)	TEMP. (°C)	REFRIG.	NW / GW (kg)
	L	W	H					
SUSHI-R120-S	120	37,5	67,5	100	415	+2 ~ +8	R134a	72 / 92
SUSHI-R150-S	150	37,5	67,5	135	430	+2 ~ +8	R134a	82 / 107
SUSHI-R180-S	180	37,5	67,5	162	445	+2 ~ +8	R134a	92 / 122



NA-530V



NA-540V



NA-550V

Temp. +2~+8°C



Features

- High humidity design (60 - 70%)
- Digital thermostat
- Low noise
- Internal lamp canopy + shelves
- Automatic defrost system
- Anti sweating glass

TYPE	DIMENSION (cm)			SHELF (pcs)	VOL. (L)	WATT (220V/1P)	WEIGHT (kg) Nett Gross	REFR.
	L	W	H					
NA-530V	90	53,3	82	1	140	439	110 / 129	
NA-540V	120	53,3	82	1	190	544	130 / 150	R290
NA-550V	150	53,3	82	1	240	649	155 / 172	



NS-530A



NS-540A



NS-550A

TYPE	DIMENSION (cm)			SHELF (pcs)	VOL. (L)	WATT (220V/1P)	WEIGHT (kg) Nett Gross	REFR.
	L	W	H					
NS-530A	90	53,6	81,6	1	115	424	124 / 142	
NS-540A	120	53,6	81,6	1	155	529	145 / 174	R290
NS-550A	150	53,6	81,6	1	200	634	162 / 205	



Curved Glass Cake Showcase

Temp. +2~+8°C



ARC-271Y



ARC-371Y



ARC-471Y



ARC-571Y

Features

- Black painted 430 Stainless steel
- Cool white LED light
- 3 adjustable glass shelf
- Double front+left+right heating glass (all tempered)
- Anti condensation air blow system
- Digital thermostat
- Automatic defrost

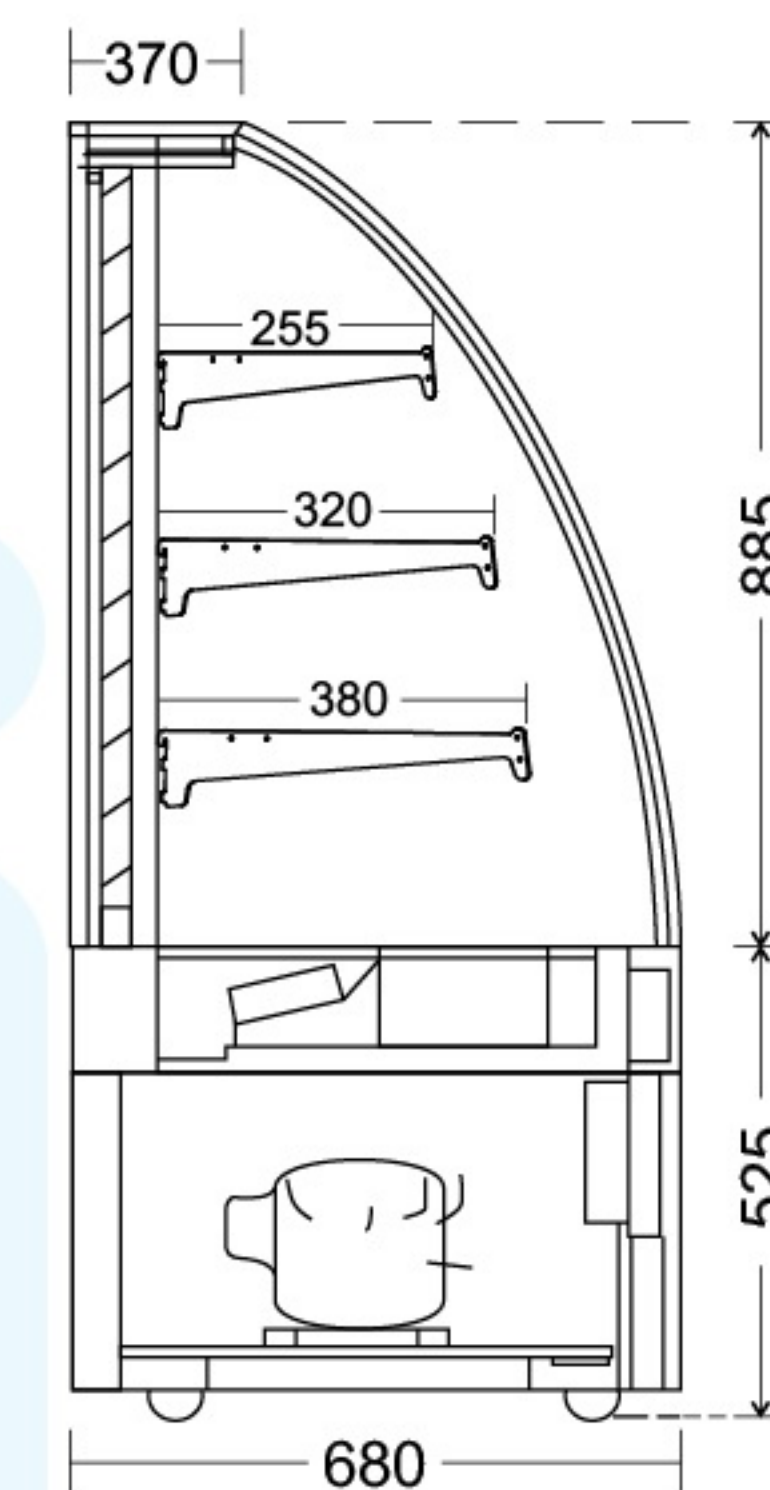

TYPE	DIMENSION (cm)			VOL. (L)	WATT (220V/1P)	REFRIG.	TEMP. (°C)	SHELF (pcs)	WEIGHT (kg) Nett Gross
	L	W	H						
ARC-271Y	92,5	68	141	310	525			3	146 / 175
ARC-371Y	122,5	68	141	420	540	R290	+2 ~ +8	3	177 / 212
ARC-471Y	152,5	68	141	535	500			3	210 / 246
ARC-571Y	182,5	68	141	650	600			3	235 / 280

Hot & Cold Cake Showcase



DS-950BS

Temp. +2~+8°C

Temp. +40~+60°C



Features

- Two temperature zones : Hot (1/3) and Cool (2/3)
- Perfect for café and cake shop
- Humidity 60 - 70%
- Digital thermostat
- Light / heat switch
- Black stainless steel

TYPE	DIMENSION (cm)			VOLUME (L)		TEMP. (°C)		WATT (220V/1P)	REFRIG.	WEIGHT (kg) Nett Gross
	L	W	H	HOT	COOL	HOT	COOL			
DS-950BS	150	80	137	210	420	+40 ~ +60	+6 ~ +12	1790	R134a	305 / 355

Rectangular Cake Showcase (White)

Kabinet display cake panel dengan warna panel stainless steel putih, tampil elegan sesuai trend. Cocok untuk display produk cake, black forest, puding, coklat, pie buah, dll. Dengan tingkat kelembapan tinggi (70% - 80%), ideal untuk menjaga kesegaran produk.



Temp. +2~+8°C

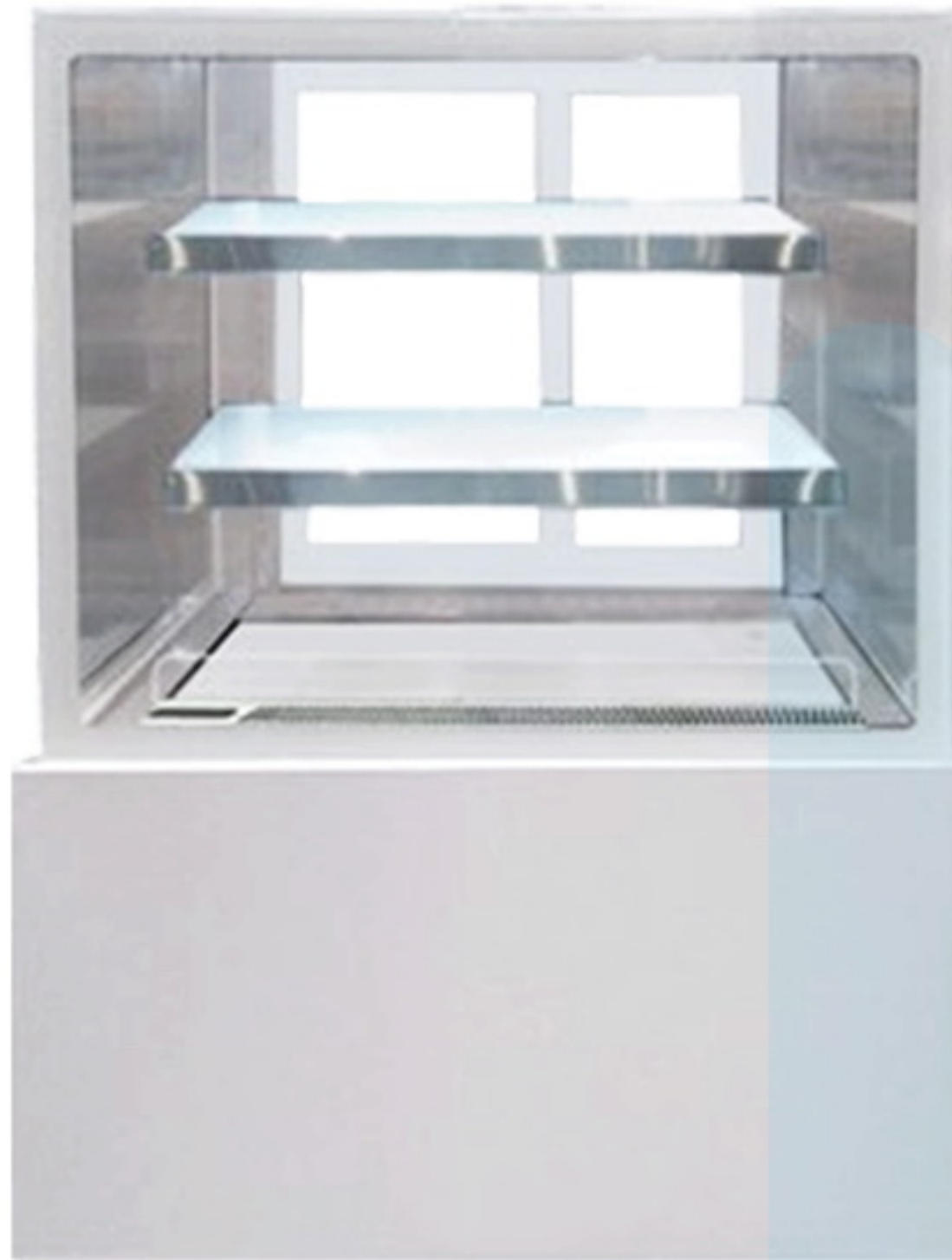

MR730V

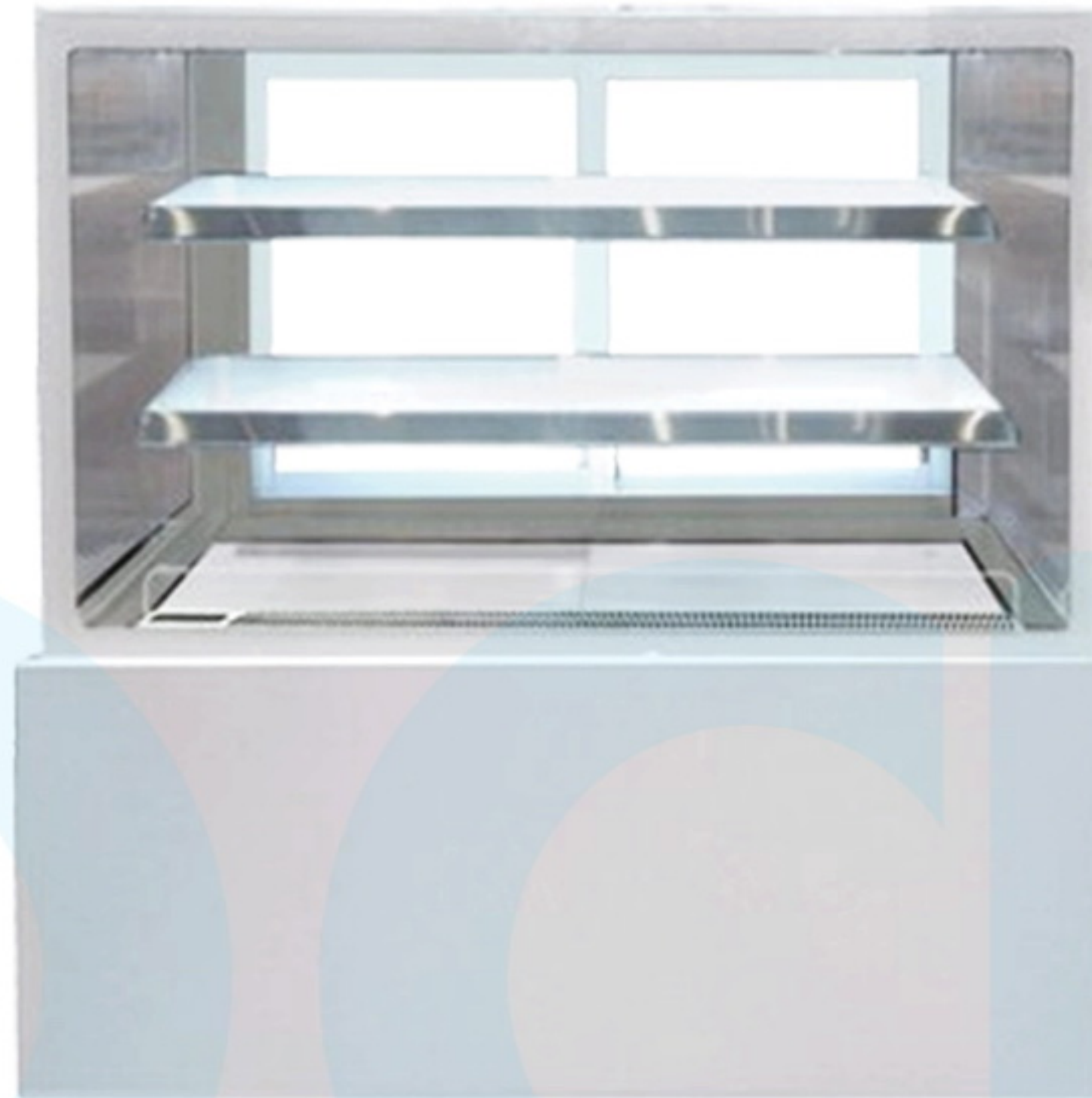

MR740V

Features

- Fan cooling system
- Cool white LED light
- Automatic defrosting
- Digital thermostat "Carel"
- Digital temperature display
- White stainless steel panel
- Power/light button
- White shelves

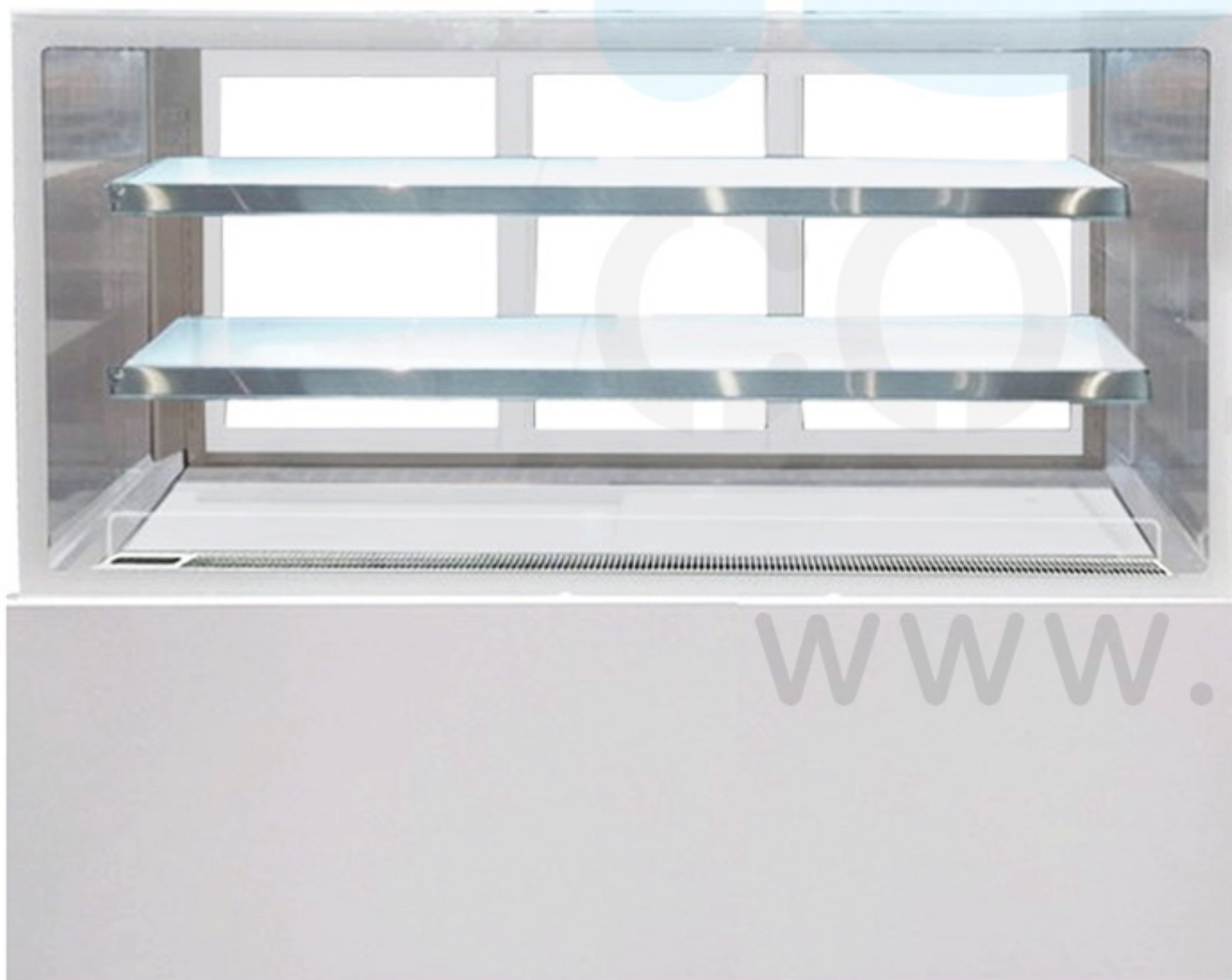

MR750V



MR760V

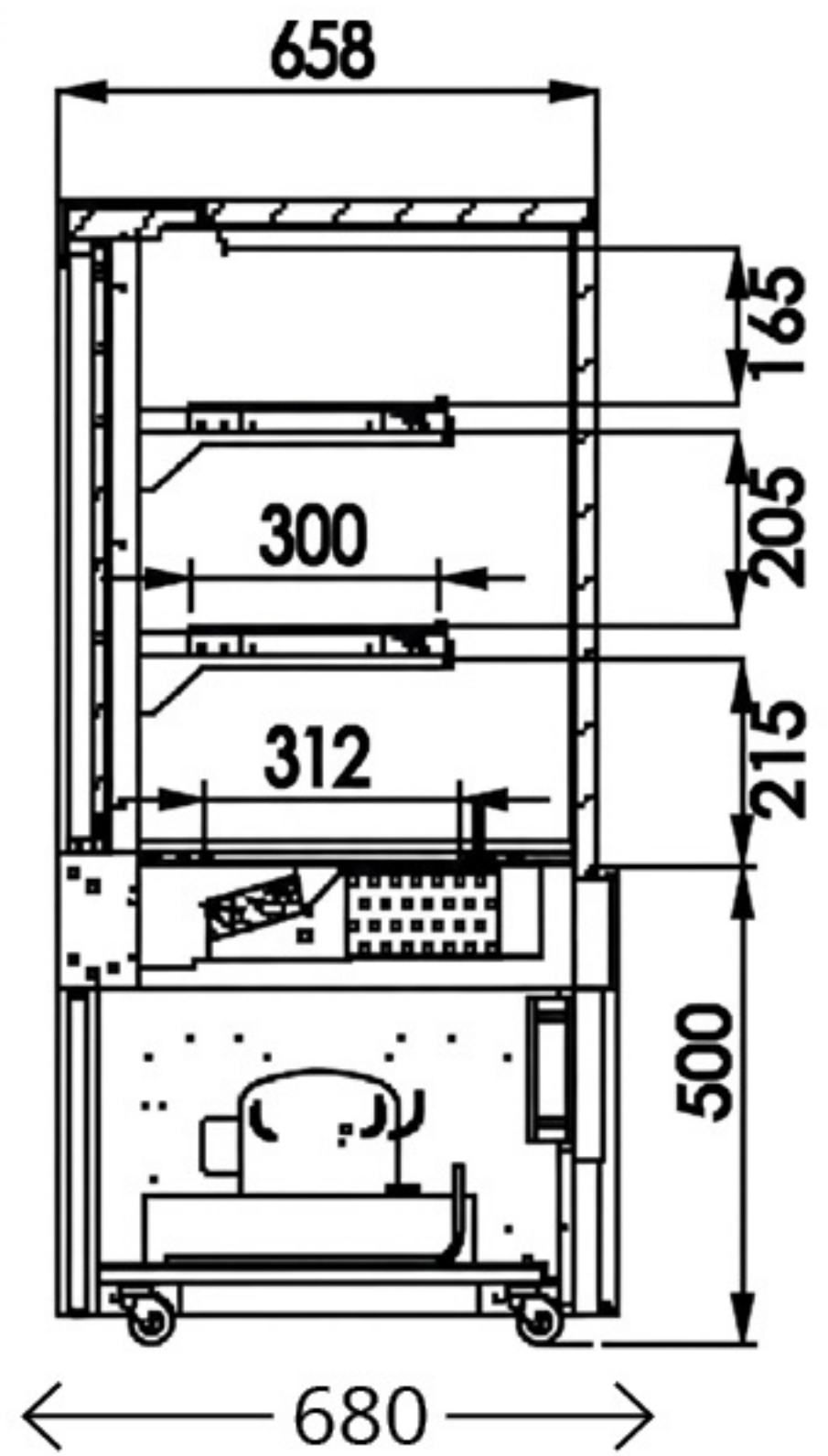

TYPE	DIMENSION (cm)			VOLUME (L)	TEMP. (°C)	SHELF (pcs)	WATT (220V/1P)	REFR.	NW/GW (kg)
	L	W	H						
MR730V	90	68	120	240	+2 ~ +8	2	460	R290	145/175
MR740V	120	68	120	330		2	519		175/205
MR750V	150	68	120	420		2	768		210/240
MR760V	180	68	120	510		2	1050		250/280



Rectangular Cake Showcase (Black)

Kabinet display cake panel dengan warna panel stainless steel hitam tampil elegan sesuai trend kebutuhan masa kini. Cocok untuk display produk cake, black forest, puding, coklat, pie buah, dll.



Temp. +2~+8°C



MSR730V



MSR740V

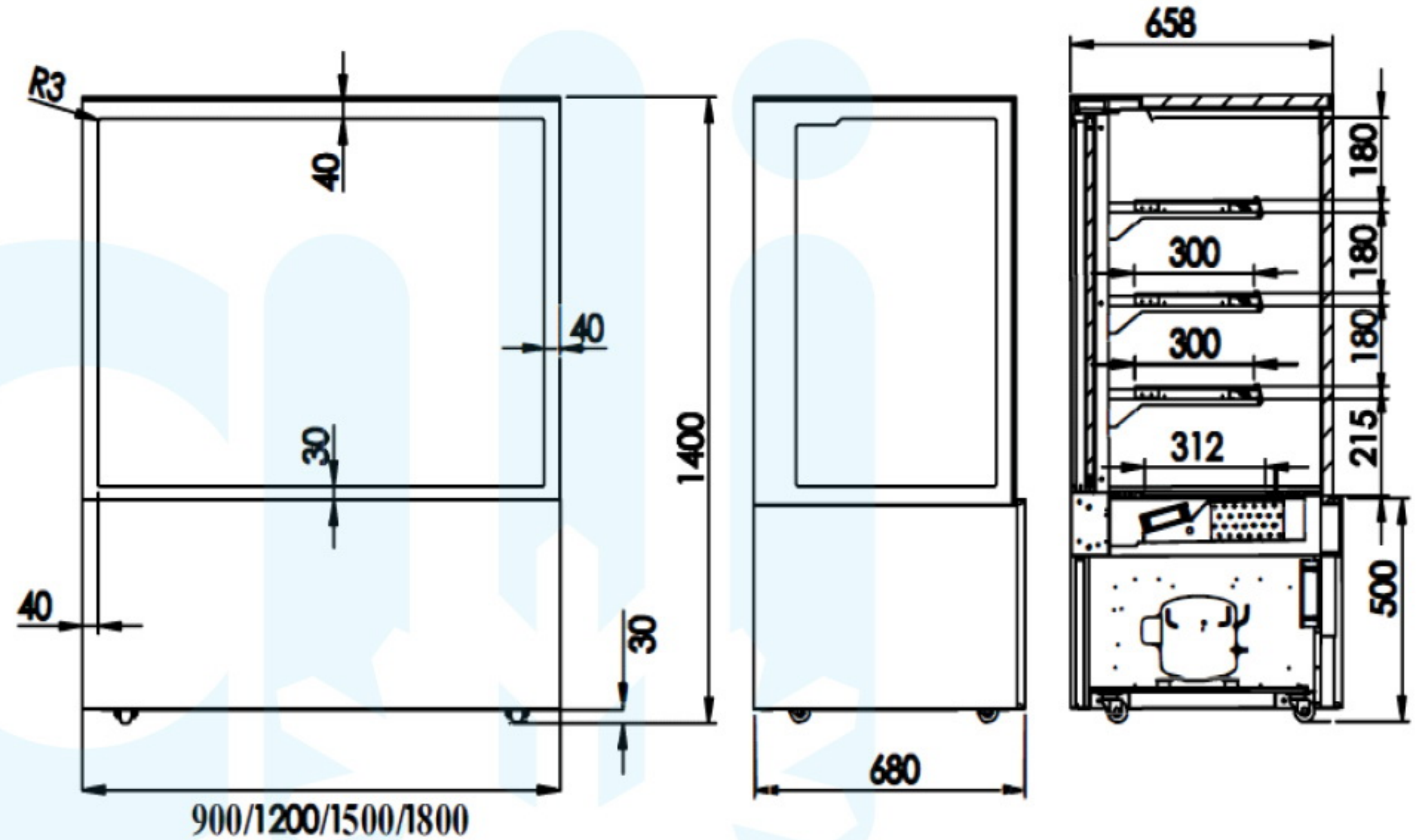

MSR750V



MSR760V

Features

- Digital controller
- Double insulated super white tempered glass (without heater)
- LED Light
- Sliding door (rear)
- Adjustable shelves
- Independent compressor deck, drawer type electrical board easy for maintenance
- Anti condensation air blow system

TYPE	DIMENSION (cm)			VOLUME (L)	WATT (220V/1P)	SHELF (pcs)	REFRIG.	WEIGHT (kg)	
	L	W	H					Nett	Gross
MSR730V	90	68	140	350	487	3	R290	165 / 195	
MSR740V	120	68	140	480	668		R290	200 / 230	
MSR750V	150	68	140	605	862		R290	240 / 270	
MSR760V	180	68	140	750	1150		R290	280 / 310	





Upright Cake Showcase

Showcase body stainless steel black ini tampil elegan dan fungsional, untuk memajang aneka cake, tiramisu, black forest, puding, coklat, fruit jelly cake, hingga pie buah dengan tampilan elegan, dilengkapi lampu internal LED yang terang untuk daya tarik pelanggan.



LS-15C

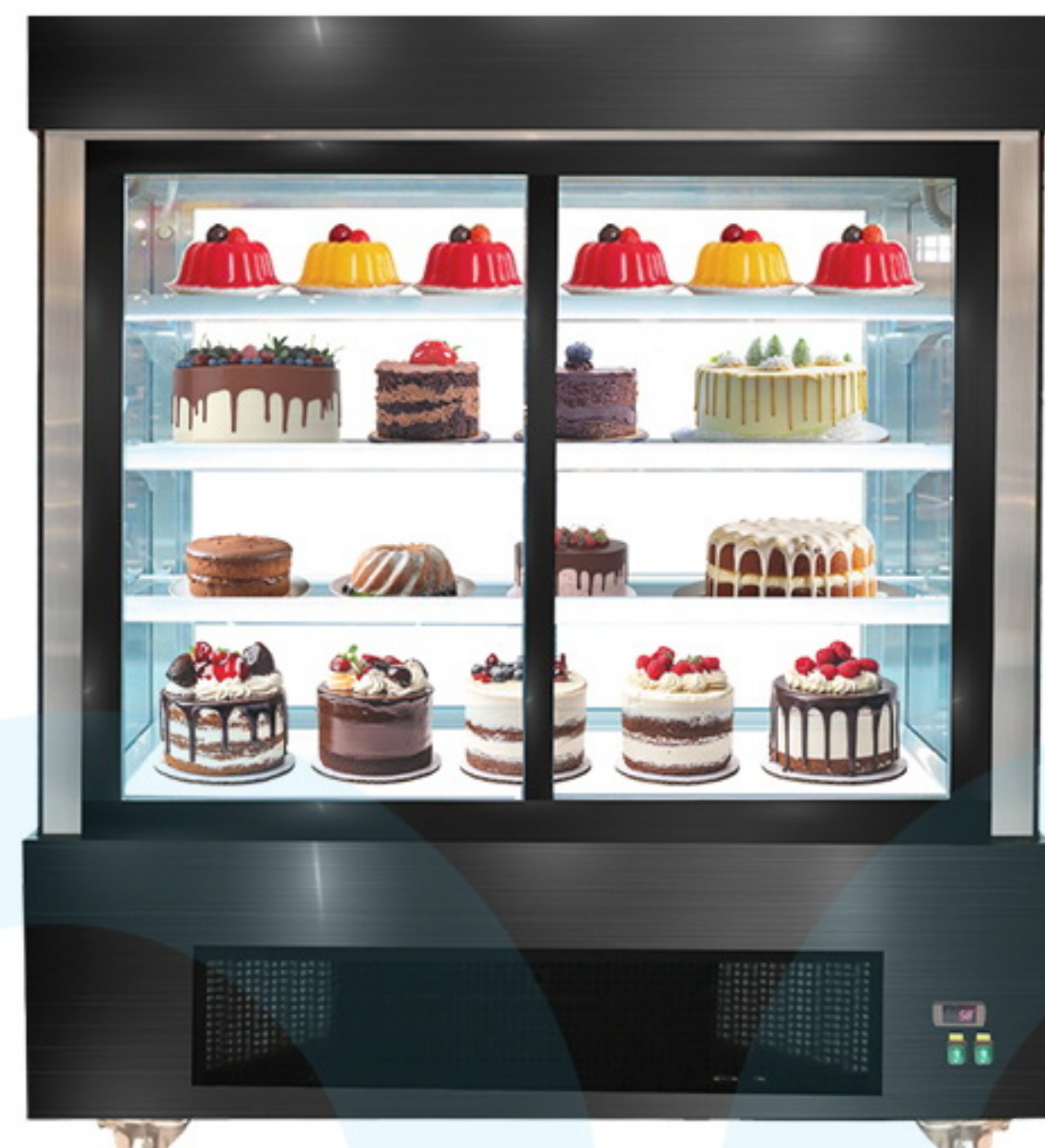

LS-18C



Contoh aplikasi untuk display minuman



(Back View)



Features

- Digital thermostat, Dixell
- Internal LED light
- Sliding door with heating film + door heater, 4 sides glass heating film
- Automatic defrost
- Fan cooling system
- Power / interior LED light switch
- Body black stainless steel
- Secop compressor (LS-18C), copper evaporator
- Removeable condensing unit

TYPE	DIMENSION (cm)			SHELF (pcs)	VOLUME (L)		WATT (220V/1P)	TEMP.	REFR.	WEIGHT (kg) NW/GW
	L	W	H		Nett	Gross				
LS-12C	120	72	190	3	450	640	1260		R404a	295 / 345
LS-15C	150	72	190	3	590	820	1580	+2 ~ +12	R404a	316 / 373
LS-18C	180	72	190	3	730	1000	1800		R404a	335 / 395

Upright Display Chiller Showcase

Features

- Digital thermostat (Dixell)
- Compressor: Embraco
- LED internal vertical light
- Large display area and storage space
- Double tempered low-E glass
- Adjustable shelf (50 cm depth)
- Automatic defrost, drain tray
- Power / lamp switch, castor
- Modular cabinet showcase



Top Monoblock Condensing Unit, easy to maintain

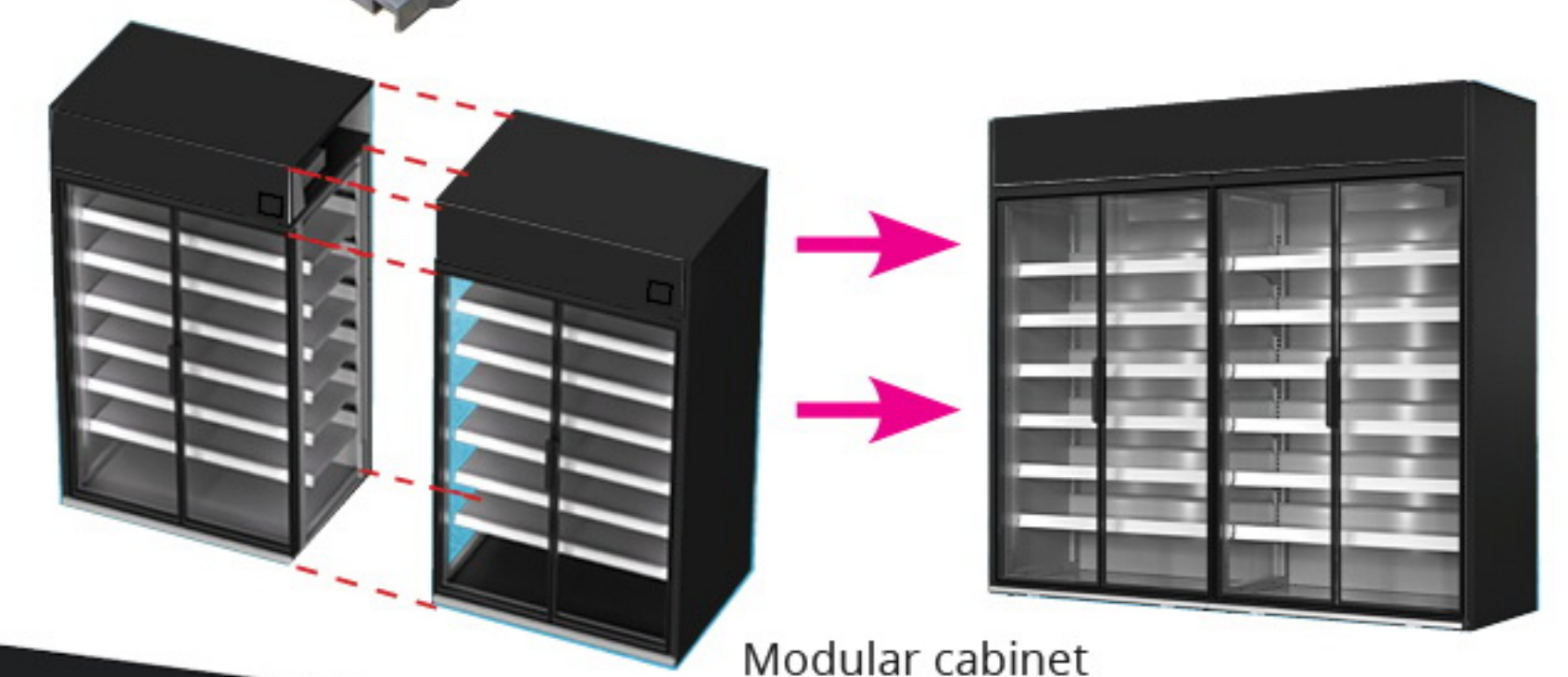

Modular cabinet



FUJI-250



FUJI-375



FUJI-500

TYPE	DIMENSION (cm)			VOL. (L)	DISPLAY AREA (M ²)	Door Qty. (pcs)	POWER (220V/1P)	TEMP. (°C)	REFRIG (R290)	NW/GW (Kg)
	L	W	H							
FUJI-250	254	75	235	2250	4086	4	520W x 2		2x160gr	245x2/270x2
FUJI-375	379	75	235	3375	6129	6	520W x 3	+2 ~ +10	3x160gr	245x3/270x3
FUJI-500	504	75	235	4500	8172	8	520W x 4		4x160gr	245x4/270x4

Rectangular Cake Showcase with Drawer

GEA

bali
coolers

www.balicoolers.com



Features

- Black stainless steel panel
- Digital thermostat
- Automatic defrosting system
- Fan cooling system
- ITO glass
- Wheel
- Max loading height 29 cm
- Display drawer
- LED lamp
- Temperature: +2 ~ +8°C



P-720VT1



P-740VT2

Display Drawer

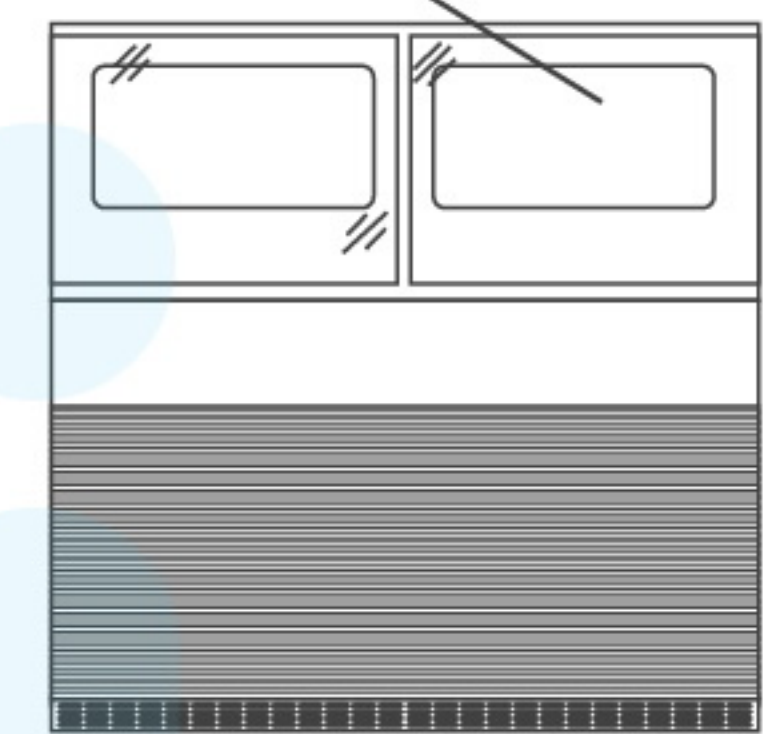

TYPE	DIMENSION (cm)			DRAWER	VOL. (L)	WATT (220V/1P)	REFR.	WEIGHT (kg)	
	L	W	H					Nett	Gross
P-720VT1	60	70	120	1	97	650	R134a	110 / 149	
P-740VT2	120	70	120	2	194	750		120 / 238	

Features

- White granite panel
- LED lamp
- Digital thermostat
- Max cake dimension \varnothing 49.5 x 21.5 cm (H)
- Temp: +2 ~ +8°C
- Stock drawer
- Display drawer



MM880V

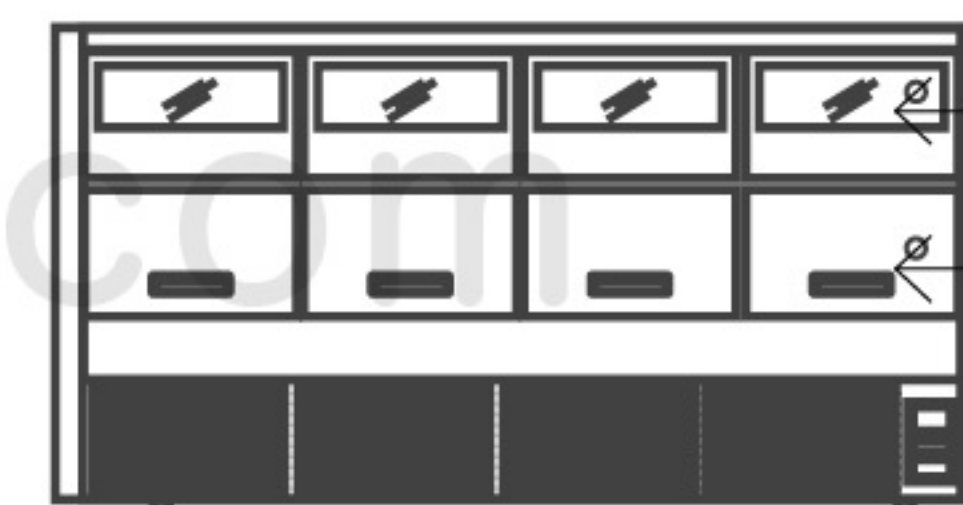

Display drawer

Stock drawer

Cake Showcase juga dapat berfungsi sebagai Chocolate Showcase (+15 ~ +18°C)

TYPE	DIMENSION (cm)			SHELF	VOL. (L)	WATT (220V/1P)	WEIGHT (kg)		REFR.
	L	W	H				Nett	Gross	
MM880V	240	79	120	4 + 4	500	1876	473 / 545		R404a

