

GETRA

bali
coolers
www.balicoolers.com

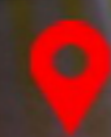

Bar, Corner,
Kiosk & Hotel
Equipment



Toaster

GETRA[®]

bali
coolers

www.balicoolers.com



Manual & Automatic Pop Up Slot Toaster

4 Slot Toaster



EST-AP-4 (Pop Up)

6 Slot Toaster



EST-AP-6 (Pop Up)

Features

- Auto Pop-Up (EST-AP Series)
- Stainless Steel Body
- Thermostat
- Timer
- Button Selection Number of
EST-4 : 2 & 4 sheet choices
EST-6 : 2, 4 and 6 sheet choices
- Stainless Steel Trays
- Bread Lever
- Indicator Light

Perbedaan sistem ungkit dan otomatis ialah pada saat alarm timer, sistem manual tuas harus diangkat untuk mengungkit roti, sedangkan sistem auto pop-up otomatis naik sendiri, sehingga mencegah roti gosong

MODEL	DIMENSION (cm)			CAPACITY (Bread)	WATT (220V/1P/50Hz)	WEIGHT (kg)	INFORMATION
	L	W	H				
EST-4	30	22,5	21,5	4 pcs	1800	4,5	Lever System/ Manual
EST-6	43	22,5	21,5	6 pcs	2500	5,5	
EST-AP-4	31	27	22	4 pcs	1800	4,5	Auto Pop-up
EST-AP-6	41	27	22	6 pcs	2500	5,5	

Conveyor Toaster

Alat untuk memanggang roti tawar dengan elemen pemanas dengan sistem mekanik konveyor. Dilengkapi dengan timer dan switch selector, alat ini memiliki kapasitas produksi 150 ~ 300 lembar roti/jam.



ECT-2415



ECT-2430



MODEL	DIMENSION (cm)			CAPACITY (/hour)	WATT (220V/1P)	CONVEYOR WIDTH (cm)	WEIGHT (kg)
	L	W	H				
ECT-2415	30	42	39,5	± 150 pcs	1450	19	11,5
ECT-2430	37	42	42	± 300 pcs	2240	36	15,4



GETRA®

Crepes Baker

bali
coolers

www.balicoolers.com



LOW PRESSURED



Electric



LCM-1E

Gas



LCM-1G

Features

- Stainless steel
- Cook plate Teflon coating
- Round base
- Spatula
- Temperature: 60 ~ 300 °C

TYPE	DIMENSION (cm)			HEAD (cm)	POWER		Gas Cons. (Kg/hour)	WEIGHT (kg) Nett Gross
	L	W	H		Electricity	Gas		
LCM-1E	45	47	25,5	Ø 40	3 kW (220V/1P)	-	-	12,5 / 14,5
LCM-1G	45	47	25,5	Ø 40	-	10 kW	0,73	11,5 / 13,5

Electrical Contact Grill

Memanggang Roti tawar , steak, sandwich & sejenisnya



CG-22

Grill Dimension
(21,5x23cm)



CG-34

Grill Dimension
(34,5x23cm)

Features

- Ribbed Cast Iron
- Thermostat ~ 250°C

TYPE	DIMENSION (cm)			GRILL SURFACE (cm)	WATT (220V/1P)	WEIGHT (kg)
	L	W	H			
CG-22	30	39	21,5	21,5 x 23	1800	14,5
CG-34	42	39	21,5	34,5 x 23	2200	19



All products in this page are made in China





Egg Waffle Baker



LOW PRESSURE



TYPE	DIMENSION			POWER	Gas Cons. (Kg/hour)	WEIGHT (kg)
	L	W	H (cm)			
SC-X30	45	24	25	1400 W (220V/1P)	-	6
SC-X36	45	24	25	2,7 kW	0,20	6,5

Waffle Baker

Diameter Round :
Ø 18 CM

Square Dimension :
20x20 CM



TYPE	DIMENSION			POWER	WEIGHT (kg)
	L	W	H (cm)		
WB-1H	36	25,2	23	1000 W	6
WB-22	46,5	38	32	1500 W	19,5

Fish Waffle Baker

LOW PRESSURE



Ikan mulut terbuka

Ikan mulut tertutup



Body : Stainless Steel

TYPE	DIMENSION			POWER	Gas Cons. (Kg/hour)	WEIGHT (kg)
	L	W	H (cm)			
SC-KR5	70	41	24	2 x 5 kW	0,73	18
SC-DY22	70	41	24	2 x 5 kW	0,73	14





Takoyaki Baker

LOW PRESSURED



- Electric**
- One board contains 28 pcs
 - Tokoyaki diameter of 40 mm



ET-YW-2

- Gas**
- One board contains 28 pcs
 - Tokoyaki diameter of 40 mm



ET-RYW-2

TYPE	DIMENSION (cm)			POWER		Gas Cons. (Kg/hour)	WEIGHT (kg)
	L	W	H	Gas	Electricity (220V/1P)		
ET-YW-2	49,5	56	24	-	2 x 2000 kW	-	18
ET-RYW-2	49,5	52,5	25,5	2 x 5 kW	-	0,73	18

Dorayaki Baker

Ukuran Dorayaki: Ø 6,5 x 2 cm

Gas **LOW PRESSURED**

Electric



FY-9A

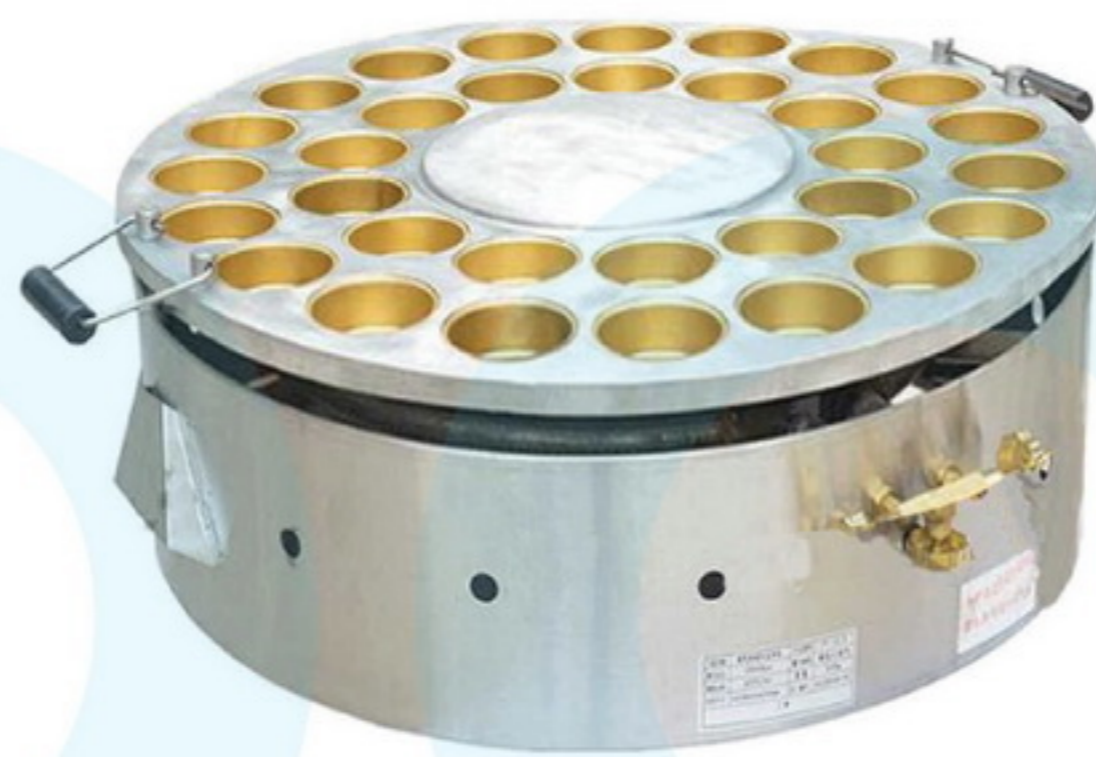

FY-32R



FY-9

TYPE	DIMENSION (cm)			POWER		Gas Cons. (Kg/hour)	WEIGHT (kg)
	L	W	H	Gas	Electricity (220V/1P)		
FY-9A	35	40	19	5 kW	-	0,36	13
FY-9	35	40	19	-	2500 W	-	12
FY-32R	-	Ø 61	22	8 kW	-	0,58	16 / 20

Cone Baker

Diameter Round :
Ø 21 CM

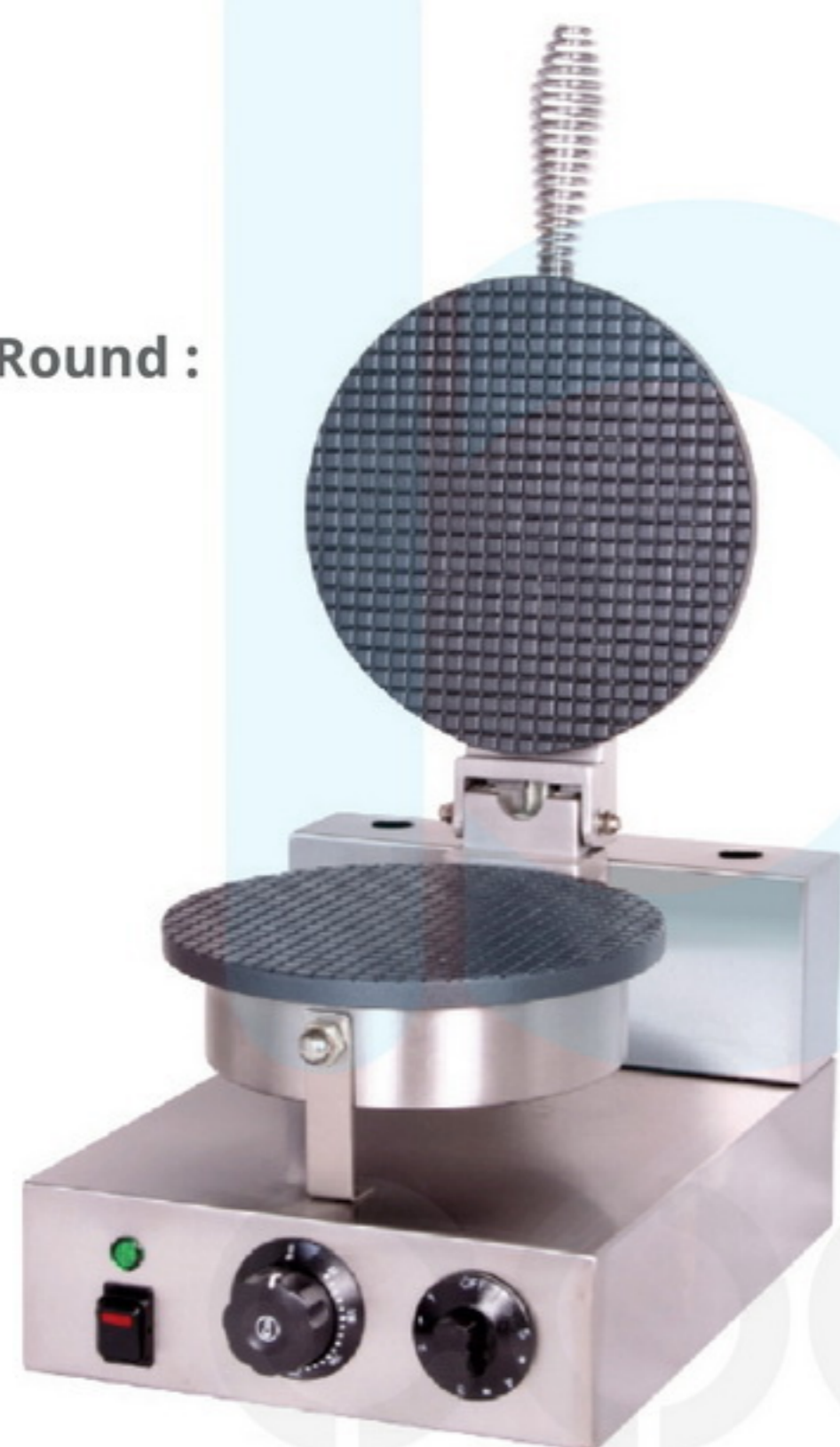

CB-1H



TYPE	DIMENSION (cm)			POWER (220V/1P)	WEIGHT (kg)
	L	W	H		
CB-1H	25	45	30	1000 W	8,2





Hot Dog Baker



Mesin untuk memanggang Hot Dog dan Sosis

Features

- 7 teflon coated rollers
- Heater in the roller



ET-R2-7

Features

- 5 & 7 teflon coated rollers
- Heater in the roller
- Stainless steel body & roller



SC-R2-5

- 30 cm roller long (R2-5), 46 cm (R2-7)
- S/s glass fitting



SC-R2-7

TYPE	DIMENSION (cm)			POWER (220V/1P/50Hz)	WEIGHT (kg)
	L	W	H		
ET-R2-7	58,5	33	20	1160 W	12,5
SC-R2-5	56,2	25	41,8	1000 W	7,1 / 8,5
SC-R2-7	56,2	32,5	41,8	1400 W	9,1 / 10,75

Corn Baker

Mesin untuk membakar jagung/sate yang dilengkapi dengan kipas blower dan rantai untuk memutar stick, sehingga panas lebih merata. Bisa juga digunakan untuk membuat steak daging, ikan, dan ayam. Cocok untuk usaha restoran, cafe, dll.



Sudah termasuk stick (tusukan) 12 pcs
Optional S/s Stick for KE-102 : Rp. 12.500,- /buah



KE-102

TYPE	DIMENSION (cm)			RACK DIMENS. (cm)		POWER		Gas Cons. (Kg/hour)	WEIGHT (kg)
	L	W	H	L	W	Gas	Electricity		
KE-102	68	40	22,5	40	23	2 x 8,2 kW	16 W/1P	1,19	7,1





Pop Corn Machine



TYPE	DIMENSION (cm)			PRODUCTION CAP. (gram/minute)	WATT (220V/1P)	WEIGHT (kg)
	L	W	H			
ET-POP6A-R	55	42	77	220 g / 2mnt	1350	24
ET-POP6C	92	38	83	-	-	10
ET-POP6A-D	89,5	41,5	74,5	220 g / 2mnt	1730	30

Commercial Cotton Candy

Mesin untuk membuat mesin gulali (permen kapas) dipakai dalam skala komersial



TYPE	DIMENSION (cm)			PRODUCT. CAP. (gram/minute)	POWER		Gas Cons. (Kg/hour)	WEIGHT (kg)
	L	W	H		Electricity	Gas		
ET-MF-05	52	75	91	40~60 stick/hour	1030 W (220V)	-	-	20
ET-MF-JZ-520	52	52	35	Cover	-	-	-	-
ET-MF01	52	52	50	40~60 stick/hour	1030 W (220V)	-	-	13
ET-RMF01	52	52	50	40~60 stick/hour	80 W (Motor)	50 KW	3,63	14,2





SC-P16-1 SC-P32-1



Features

- Full stainless steel body S/s 201
- Production time : 4 ~ 5 minutes per cycle
- 3 Phase Heater (380V/3P)
- Internal light, storage cabinet + drawer
- Teflon non-stick bowl, easy to clean
- Knob switch thermostat
- Castor feet
- Perforated plate for oil drain

Mesin untuk membuat pop corn secara otomatis, membantu Anda memproduksi pop corn yang istimewa secara efisien. Dengan body dari stainless steel menambah kesan elegan dan menjaga higienitas produk. Pembuatan pop corn jadi lebih mudah, menghasilkan produk yang memuaskan bagi penggemar popcorn terutama di Mall, Gedung Bioskop, Snack Bar, Arena Rekreasi, dan wahana hiburan lainnya.



(Tampak Depan)



Pop Corn Warmer

Kabinet display stainless steel khusus untuk menghangatkan dan memajang popcorn dan aneka produk snack lainnya dengan sesuai rasa, tersedia dalam 2 model : pop corn warmer 2 dan 3 chamber.

Sajikan popcorn hangat dan fresh! Warmer ini dirancang untuk menjaga kualitas popcorn dan daya tarik kustomer, karena dilengkapi lampu internal, kaca tahan panas di bagian depan dan atas, juga thermostat knob untuk mengatur suhu yang diinginkan.



SC-BG90

Features

- Full stainless steel body S/s 201
- Single Phase Heater
- Knob switch thermostat (30 ~ 85°C)
- Drawer

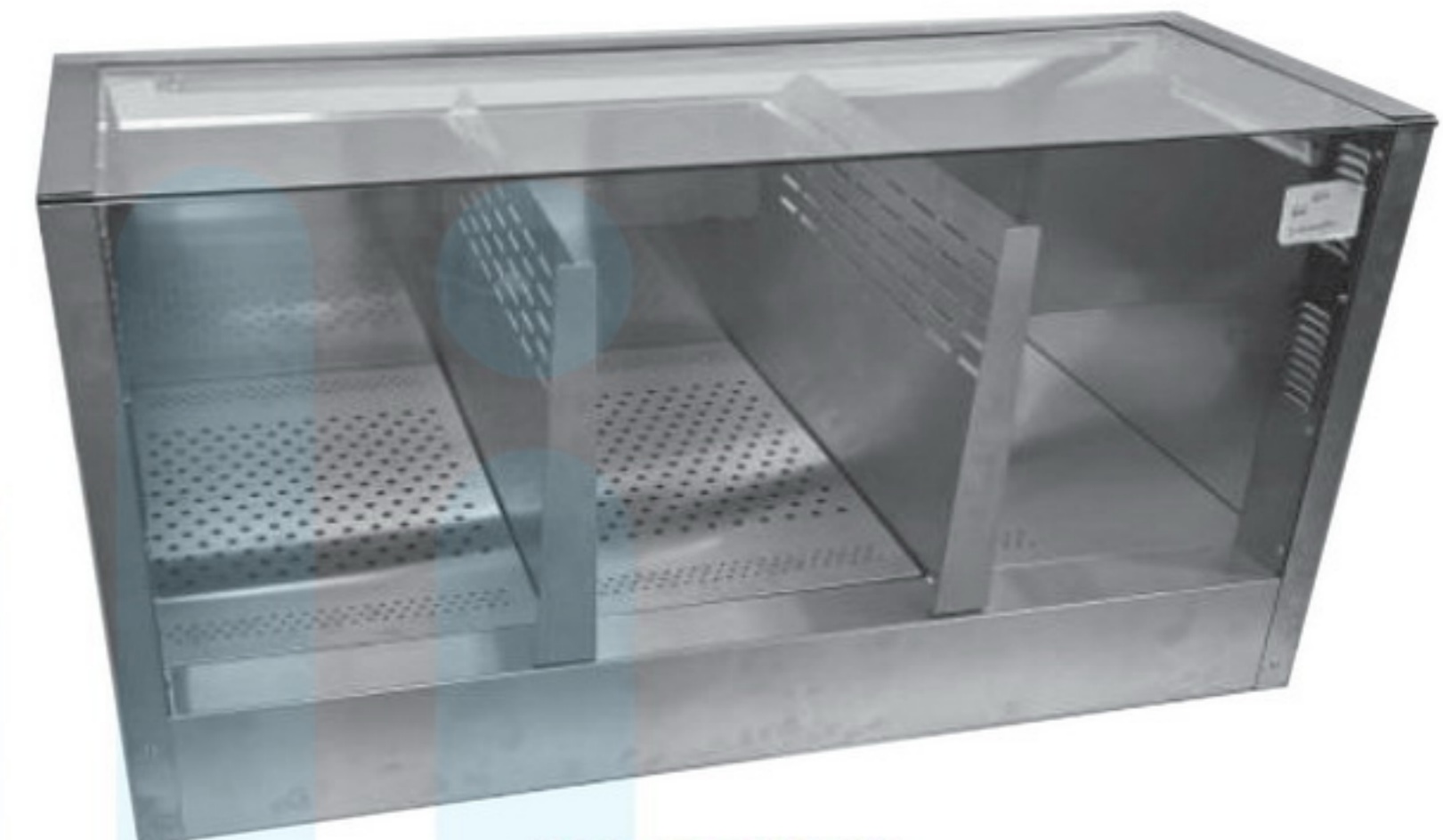

SC-BG120

TYPE	DIMENSION (cm)			CAPACITY		WATT	TEMP. (°C)	WEIGHT (NW/GW) (kg)
	L	W	H	Production (gr/min)	Bowl			
SC-P16-1	83	60	187	90	1 x 450gr	3400 (380V)	30 ~ 80	128 / 178
SC-P32-1	91,5	72,5	195,5	180	1 x 900gr	3900 (380V)	30 ~ 80	166 / 216
SC-BG90	90	78	77,5	90 L (2 chambers)		1400 (220V)	30 ~ 85	50 / 75
SC-BG120	120	77	68	120 L (3 chambers)		1400 (220V)	30 ~ 85	65,5 / 95,5





Electric Food Warmer

Untuk menghangatkan produk makanan cepat saji (fast food): Hamburger, kentang goreng, ayam goreng, dll.



Front Flat Glass



RTR-130L-1



RTR-160L-2

Features

- Internal LED (on top)
- Adjustable temperature controller
- Temperature display
- Adjustable chrome plated shelves
- Sliding door

TYPE	DIMENSION (cm)			VOLUME (l)	WATT (220V/1P)	TEMP. (°C)	WEIGHT (kg) Nett Gross
	L	W	H				
RTR-130L-1	67,8	57,8	69,8	130	1100	30 ~ 90	34,5/38
RTR-160L-2	85,7	57,8	69,8	160	1500	30 ~ 90	42/45,5

Pizza Warmer

Features

- Internal LED (on side)
- Adjustable temperature controller
- Temperature display
- Rotational chrome plated shelves
- Ø Pizza: 355 mm



RTR-108L

Features

- Adjustable temperature controller
- Temperature display
- Adjustable chrome plated shelves
- Back door
- Front top light box



RTR-97L

Features

- Adjustable temperature controller
- Temperature display
- Adjustable chrome plated shelves
- Back door
- Front top light box



RTR-137L

TYPE	DIMENSION (cm)			VOLUME (l)	WATT (220V/1P)	TEMP. (°C)	WEIGHT (kg) Nett Gross
	L	W	H				
RTR-108L	47	47	87	108	1200	30 ~ 90	33/35
RTR-97L	46	44,8	78,5	97	800	30 ~ 90	22/24
RTR-137L	64,5	48,7	78,5	137	1100	30 ~ 90	27/29





Electric Food Warmer

Front & Rear Sliding Door

Features

- Thermostat
- Thermometer
- Tempered glass
- LED light
- Adjst. shelves
- High humidity
- Water pan



RTR-96L

RTR-136L

TYPE	DIMENSION (cm)			VOLUME (l)	WATT (220V/1P)	TEMP. (°C)	WEIGHT (kg) Nett Gross
	L	W	H				
RTR-96L	67,4	48,4	66,2	96	1000	30 ~ 70	33,5 / 36
RTR-136L	91,5	48,4	66,2	136	1100	30 ~ 70	41,5 / 43,5
RTR-2D	62,5	52	65	-	560	30 ~ 85	25,6 / 28

Open Display Warmer



Features

- Internal Lamp
- Thermostat
- Fixed shelf
- Rubber feet
- S/S body
- Display area : 0.48m³
- Rear reflective glass solid



RTR-2D

Rear Sliding Door



RTR-120L

RTR-160L

Features

- Adjustable temperature control
- Tempered glass
- LED light
- Analogue thermometer
- Adjustable shelves
- High humidity
- Stainless steel body
- Water pan

TYPE	DIMENSION (cm)			VOLUME (l)	WATT (220V/1P)	TEMP. (°C)	WEIGHT (kg) Nett Gross
	L	W	H				
RTR-120L	67,8	56,8	67	120	1100	30 ~ 70	38 / 48
RTR-160L	85,6	56,8	67	160	1500	30 ~ 70	46 / 56





Electric Food Warmer

Features

- LED light on side
- Thermostat
- Non-adjustable chrome plated shelves
- Body stainless steel
- Sliding back door



RTR-80L

Features

- Thermostat
- Non-adjustable chrome plated shelves
- LED light
- Drawer with collection junk back doors
- Sliding back door



RTR-185L

TYPE	DIMENSION (cm)			VOLUME (l)	WATT (220V/1P)	TEMP. (°C)	WEIGHT (kg) Nett Gross
	L	W	H				
RTR-80L	70	40	37,6	80	1000	30 ~ 90	16,4/18,5
RTR-185L	90	55	50	185	1200	30 ~ 90	33,5/38,5



RTR-129L

Features

- LED light
- Double safety glass
- Stainless steel shelf
- Sliding back door
- Digital temperature controller and display
- Heating & humidity system in cabinet



RTR-200L

Features

- LED light
- Digital temperature controller & display
- Adjustable shelf
- 4 castors, 2 with brakes
- Body stainless steel
- Safety glasses on 2 sides



TYPE	DIMENSION (cm)			VOLUME (l)	WATT (220V/1P)	TEMP. (°C)	WEIGHT (kg) Nett Gross
	L	W	H				
RTR-129L	62,4	56	87,4	178	1400	30 ~ 80	58,5/61
RTR-200L	100	59,2	125,3	200	2100	30 ~ 80	104,5/140





Hot Display Cabinet

Display Warmer atau sering disebut showcase warmer adalah alat yang biasa digunakan untuk mendisplay makanan atau memajang produk makanan yang diijakan. Karena terbuat dari kaca anti panas, produk makanan yang didisplay akan terlihat jelas dari 4 sisi, dan higienis.



RT-650L

Features

- LED light on top
- Digital temperature controller & display
- 6 stainless steel tiers shelves
- Front lift-up door & back hinge doors

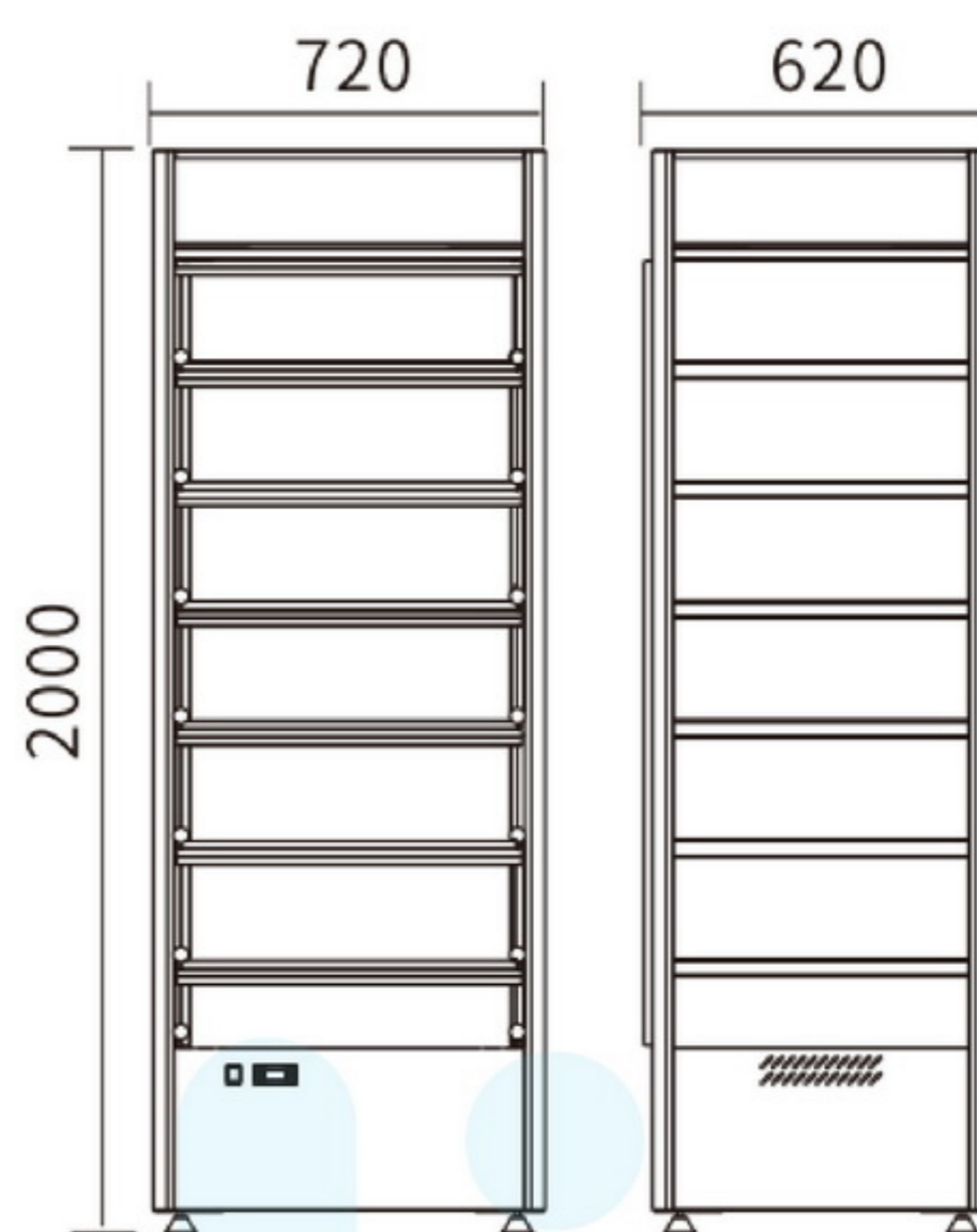

TYPE	DIMENSION (cm)			VOLUME (l)	WATT (220V/1P)	TEMP. (°C)	WEIGHT (kg) Nett Gross
	L	W	H				
RTR-650L	72	62	200	650	2200	30 ~ 70	96 / 102





Food Display Warmer

Untuk menghangatkan produk makanan cepat saji (fast food): Hamburger, kentang goreng, ayam goreng, dll.



HW-2P



HW-3P

Features

- Interior Light
- Front and rear glass doors (open top)
- Thermostat (30 ~ 90°C)
- Stainless steel body
- The inlet pipe, the water reservoir below serves to prevent drought displayed products (if a heater is not used can be removed)

TYPE	DIMENSION (cm)			WATT (220V/1P)			WEIGHT (kg) Nett Gross
	L	W	H	Dry Heater (Top)	Dry Heater (Bottom)	Wet Heater (Bottom)	
HW-2P	96	75	89	1400	1400	1000	45 / 86,5
HW-3P	152	75	89	2000	2000	1200	60 / 112



RTR-85D



RTR-138D

Features

- Interior Light (2 x 15 W)
- Adjustable divider rods for easy organize of food product
- Rubber feet
- Stainless steel exterior
- Tempered glass sides
- Heater
- Adjustable thermostat

TYPE	DIMENSION (cm)			DISPLAY AREA (m ²)	POWER (220V/1P)	WEIGHT (kg) Nett Gross
	L	W	H			
RTR-85D	80	70	69	0,85	1160 W	41 / 44
RTR-138D	125	70	69	1,38	1860 W	65



ELW-660R



ELW-990R

Features

- Interior light
- Thermostat
- Curve glass front
- GN Pan
- Shelf
- Rubber feet

TYPE	DIMENSION (cm)			WATT	VOLTAGE	TEMP. (°C)	WEIGHT Nett / Gross
	L	W	H				
ELW-660R	66	50	62	850	220V/1P/50Hz	30 ~ 80	23 / 26
ELW-990R	99	50	62	1200			





Pastry Food Warmer

Black Stainless Steel Panel

Kabinet display yang digunakan untuk menyimpan sekaligus menghangatkan roti, donat, bolu, dan beraneka macam kue kering lainnya.



Features

- Sliding glass door (easy to clean)
- Warm air is more evenly distributed throughout cabinet
- Can warm food
- High humidity (60 ~ 80%)
- The front panel is made of black stainless steel
- Digital Thermostat
- Internal light
- Light switch button
- Power switch button



H-940BS



H-950BS



H-960BS

TYPE	DIMENSION (cm)			VOL. (l)	TEMP.	WATT (220V/1P/50Hz)	WEIGHT (kg) Nett Gross
	L	W	H				
H-940BS	120	80	137	510	40 ~ 60°C	1073	225 / 270
H-950BS	150	80	137	640	40 ~ 60°C	1161	265 / 315
H-960BS	180	80	137	770	40 ~ 60°C	1320	300 / 355

Food Warmer

Kabinet display yang digunakan untuk menyimpan sekaligus menghangatkan roti, donat, bolu, dan beraneka macam kue kering lainnya.



RTR-4

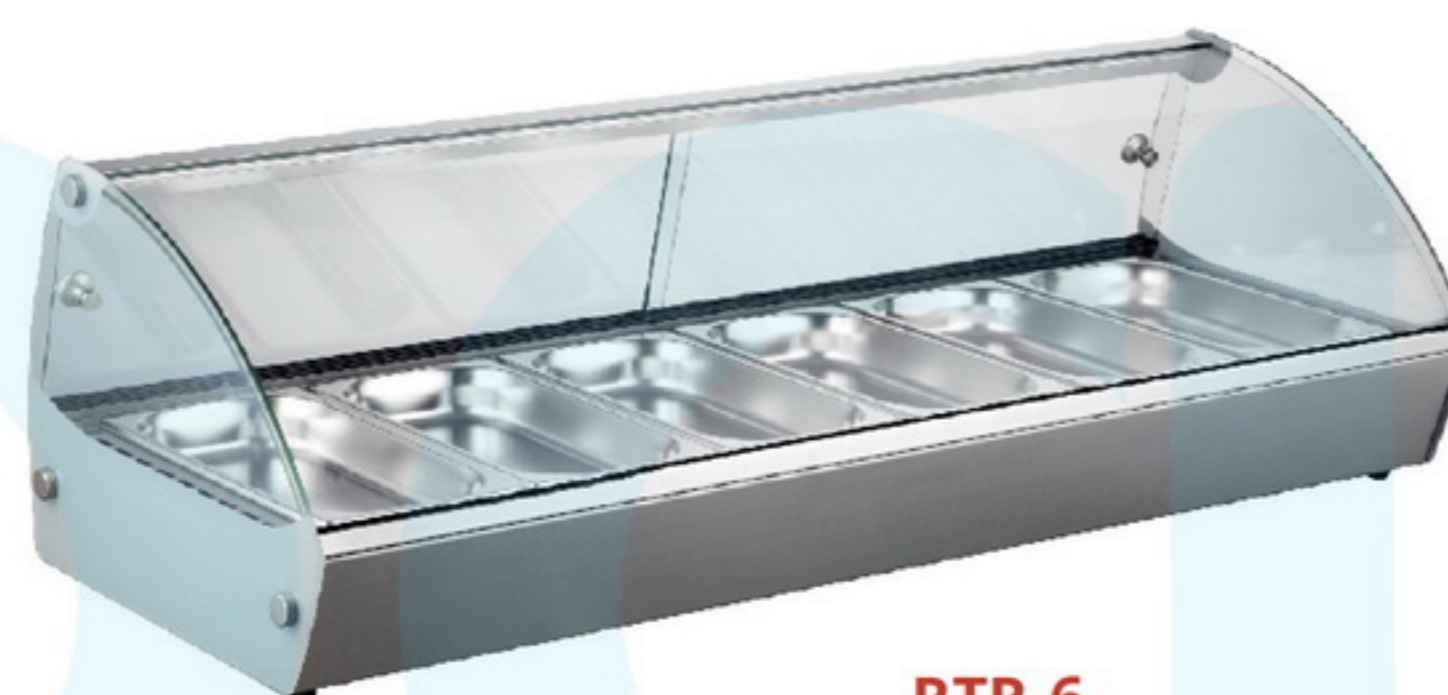

RTR-6

Features

- Includes GN Pan 1/3
- Sliding glass door
- Thermostat (30 ~ 90 °C)
- Analog Thermometer

Ruangan di bawah pan tidak boleh diisi air

TYPE	DIMENSION (cm)			VOL. (l)	PAN QUANTITY	WATT (220V/1P/50Hz)	TEMP. (°C)	WEIGHT (kg) Nett Gross
	L	W	H					
RTR-4	78	42	33,5	46	4 (1/3 GN Pan)	500 W	30 ~ 90	16 / 18
RTR-6	113	42	33,5	68	6 (1/3 GN Pan)	800 W	30 ~ 90	22 / 24





WHS-520-4

4 LAYERS PASS THROUGH HOLDING CABINET

Kabinet display dengan akses 2 arah (pass through) untuk menghangatkan sekaligus menyajikan makanan pada suhu yang diinginkan. Dilengkapi 4 buah rak dengan suhu yang bisa diatur sesuai kebutuhan dan 8 buah alarm, sehingga bisa menghangatkan berbagai jenis makanan secara bersamaan dengan suhu dan waktu yang berbeda-beda. Cocok digunakan pada dapur cepat saji dengan tingkat kesibukan yang tinggi.



1. 4 kontrol suhu digital (30 sd. 100°C) yang bekerja secara mandiri dengan power switch pada setiap raknya sehingga sangat efisien, mudah digunakan
2. Nampan polycarbonate dengan ukuran standar tahan panas hingga 190°C. Kuat dan aman untuk makanan. Dilengkapi peniris pada rak dasar

3. Teknologi WTC heat patch dan plat pemanas aluminium dengan suhu yang konstan dan merata mampu menghemat energi hingga 30% dibandingkan pemanas biasa
4. Alarm (1 detik sd. 99 menit 59 detik) dapat diatur pada 2 sisi berbeda (depan / belakang) dengan indikator waktu yang sama

TYPE	DIMENSION (cm)			CAPACITY	POWER (220V/1P)	WEIGHT (kg)
	L	W	H			
WHS-520-4	51,5	63	68	2 x PC1/1-2.5 2 x PC1/1-4	3600 W	106

Banquet Cart Warmer

TEMP. 70 ~ 85°C

Designed for safely transporting food from a kitchen to a serving / banqueting area



R16HF



Features

- Adjustable anti-tilt tray slides, match GN design (Exclude Pan)
- All round non-marking bumper for added protection during transfer of cabinet
- Built-in handles at four sides for easy mobility
- Castors for easy transporting
- Round corners design, easy for cleaning
- High density 75mm thick insulation foam with zero ODP
- Over 90° door opening allows easy loading and stock checking
- Digital controller, maintenance much easier and more effective
- Circulation with fans
- Automatic re-set safety cutout switch to prevent overheating
- Include 8 pcs stainless steel wire shelves

Note :

Kabinet ini bisa disetting suhunya kurang dari 60°C

TYPE	DIMENSION (cm)			VOLUME (l)	WATT (220V/1P/50Hz)	WEIGHT (kg)
	L	W	H			
R16HF	78,1	87,2	177	345	1430 W	107





GETRA®

Commercial Insulated Container

Cabinet 2 pintu degan insulasi rigid PU tebal hingga 5 cm, sehingga mampu mempertahankan suhu panas produk makanan / masakan yang disimpan hingga 6 sampai dengan 10 jam.
Kabinet sudah dilengkapi roda agar mudah didorong atau dipindah-pindah, cocok untuk menjaga masakan agar tetap hangat di Restoran, Hotel, Cafe, Catering, dll.



Features

- Material : PE + Rigid PU 3-5 cm
- Color : brown
- 4 castors (2")

Capacity GN pan INC-120 :

- * FP 1/1-2,5 : 8 pcs
- * FP 1/1-4 : 5 pcs
- * FP 1/1-6 : 4 pcs
- * FP 1/1-8 : 3 pcs
- * FP 1/2-2,5 : 16 pcs
- * FP 1/2-4 : 10 pcs
- * FP 1/2-6 : 8 pcs
- * FP 1/2-8 : 6 pcs

Capacity GN pan INC-180 :

- * FP 1/1-2,5 : @6pcs x 2 : 12 pcs
- * FP 1/1-4 : @4pcs x 2 : 8 pcs
- * FP 1/1-6 : @3pcs x 2 : 6 pcs
- * FP 1/1-8 : @2pcs x 2 : 4 pcs

Capacity GN pan INC-180 :

- * FP 1/2-2,5 : 24 pcs
- * FP 1/2-4 : 16 pcs
- * FP 1/2-6 : 12 pcs
- * FP 1/2-8 : 8 pcs



INC-120



INC-180



TYPE	DIMENSION UNIT			INTERNAL SIZE			CAPACITY (L)	HOLD TIME (hour)	WEIGHT (kg) Nett Gross
	(cm)			(cm)					
	L	W	H	L	W	H			
INC-120	47	67	78	33,5	53	64	120	8 ~ 10	21 / 22
INC-180	45	63	120	33,5	53	51	180	4 ~ 6	33 / 35





Bain Marie Counter

Table Top Bain Marie



TB-3

TB-4

TB-5

Ruangan di bawah pan harus diisi air

Features

- Sneeze Guard keeps the temperature / hygiene
- Stainless steel body
- Thermostat ~ 90° C
- Safeguarding excess temperature if the water tray is empty
- Including GN Pan

TYPE	DIMENSION (cm)			GN PAN QUANTITY	WATT (220V/1P/50Hz)	TEMP. (°C)	WEIGHT (kg) Nett Gross
	L	W	H				
TB-3	90,5	34	31,5	3 (1/2-4 GN Pan)	1500 W	30 ~ 90	13,2 / 15,5
TB-4	117	34	31,5	4 (1/2-4 GN Pan)	1500 W	30 ~ 90	16,2 / 19,4
TB-5	143,5	34	31,5	5 (1/2-4 GN Pan)	1800 W	30 ~ 90	20 / 22,5



ET-TEM-2V



ET-TEM-4V

Ruangan di bawah pan harus diisi air

Features

- Thermostat ~ 90° C
- Water drain valve
- Stainless steel body

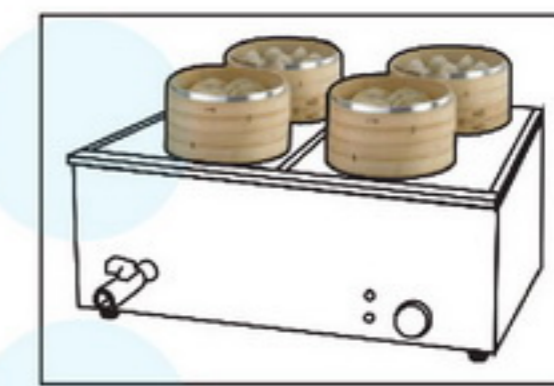

Bain marie diaplikasikan untuk Dimsum Steamer

TYPE	DIMENSION (cm)			GN PAN QUANTITY	WATT (220V/1P)	WEIGHT (kg)
	L	W	H			
ET-TEM-2V	56,5	38	22,5	2 (1/2-GN Pan)	1500 W	9
ET-TEM-4V	69	59	22,5	4 (1/2-GN Pan)	1500 W	16

Free Standing W/ Cabinet



SERI TSDGNTC

Ruangan di bawah pan harus diisi air



Features

- Water drain valve
- GN Size (Not Included)
- Slide tray
- Stainless steel body
- Castor wheel
- Thermostat ~ 90° C

TYPE	DIMENSION (cm)			WATT (220V/1P)	GN PAN QUANTITY		GROSS WEIGHT (kg)
	L	W	H		1/1-4	1/2-4	
TSDGNTC-110	110	125	80	2500	3	6	50
TSDGNTC-145	145	125	80	2500	4	8	77
TSDGNTC-178	178	125	80	2500	5	10	95





Towel Warmer



RTD-23A

Kabinet untuk memanaskan/menghangatkan handuk. Aplikasi : Hotel, Tempat Refleksi, Restoran, Sauna, Karaoke



Features

- Plastic panel frame
- Elegant Handle
- Interior Alluminium
- Plastic arc door
- Right-side opening door

TYPE	DIMENSION (cm)			WATT (220V)	CAPACITY (pcs)	VOLUME (l)	WEIGHT (kg)
	L	W	H				
RTD-23A	45	31	35.5	200	30 - 50	23	6

Plate Warmer



ST1030

Features

- Individual thermostat
- Castor



Dim Sum Trolley (Gas)



F-0021



LOW PRESSURE



Mesin untuk menghangatkan dimsum sekaligus berfungsi sebagai meja dorong yang dilengkapi dengan roda. Dilengkapi dengan rak tempat meletakkan gas untuk mengukus makanan agar kondisi makanan tetap hangat saat disajikan.

TYPE	DIMENSION (cm)			WATT (220V/1P)	PLATE CAPACITY (pcs)
	L	W	H		
ST1030	45	50	90	400	20 ~ 30
ST2030	95	40	90	400 + 400	40 ~ 60
F-0021	90	54	88	-	-

Heavy Duty Smoothies Machine



KS-778



Aplikasi :

- Juice bar untuk membuat smoothy ice
- Dengan kecepatan 26.500 rpm (bisa diatur), Super Blender ini mampu memotong buah/sayur, es batu menjadi sangat halus

Features

- ON / OFF Switch
- Speed can be adjusted
- Pulse Switch, to lift the fruit / ice cubes that are stuck

TYPE	DIMENSION (cm)			VOLUME (l)	WATT (220V/1P/50Hz)	WEIGHT (kg)
	L	W	H			
KS-778	20,5	23	51	2	1500 W	5,5



GETRA[®]

Smoothies Machine

bali
coolers 
www.balicoolers.com



Smoothy Machine



KS-1050

Aplikasi :

- Juice bar untuk membuat smoothy ice
- Dengan kecepatan 28.000 rpm (bisa diatur), Super Blender ini mampu memotong buah/sayur, es batu menjadi sangat halus

Features

- Sturdy leg construction
- 28.000 rpm speed
- ON / OFF Switch
- Speed can be adjusted
- Pulse Switch, to lift the fruit / ice cubes that are stuck

TYPE	DIMENSION (cm)			VOLUME (l)	WATT (220V/1P/50Hz)	WEIGHT (kg)
	L	W	H			
KS-1050	21,9	21,9	49	2	1500 W	6,5



Pro Commercial For Smoothies Ice Machine



KS-10000

Features

- Larger LCD display screen
- Able to crush ice for only 8 seconds
- Design is soundproof cover
- Automatic recording from the last use program
- 185 types of program modes
- Automatic shutdown for overload protection
- Containers of polycarbonate are shatter resistant
- Tungsten steel blades - Japan
- Speed: 30.000 rpm
- ON / OFF Switch
- Speed can be adjusted
- Pulse Switch, to lift the fruit / ice cubes that are stuck

TYPE	DIMENSION (cm)			VOL. (l)	WATT (220V/1P/50Hz)	WEIGHT (kg)
	L	W	H			
KS-10000	25,7	23	51,7	2	1500 W	9



Water Boiler

GETRA

bali
coolers
www.balicoolers.com



Electric Water Boiler

DIRECT CONNECT TO WATER TAP

 recommended water filter



JL-30SC

JL-60SC

JL-90SC

Features

- S/s 201 body, S/s 304 tank
- With insulation
- Dry heater
- Automatic water intake
- Indicator light of heat
- Thermometer analogue

TYPE	DIMENSION (cm)			PRODUCTION CAP. (hour)	WATT	VOLTAGE	NW/GW (kg)
	L	W	H				
JL-30SC	42	25	64	30 L	3000	220V/50Hz/1P	6,5 / 7,7
JL-60SC	42	25	71	60 L	6000	380V/50Hz/3P	7,5 / 8,9
JL-90SC	48	25	82	90 L	9000	380V/50Hz/3P	9,2 / 10,7

Cylinder Water Boiler



WB-12SC

WB-15SC

WB-20SC

WB-25SC

Features

- S/s 201 body, S/s 304 tank
- Thermostat
- Indicator light of heat
- Water level glass
- Double jacket
- Power switch

TYPE	DIMENSION (cm)		VOLUME (l)	WATT	VOLTAGE	NW/GW (kg)
	Ø	H				
WB-12SC	26,5	39	11	1800 W	220V/1P/50Hz	3,8 / 4,8
WB-15SC	26,5	46,5	15	1800 W		4,42 / 5,4
WB-20SC	31,5	46,5	19	2800 W		4,9 / 6,4
WB-25SC	31,5	52	25	2800 W		5,3 / 6,8





Cylinder Water Boiler

Restoran, hotel, kantin, kafe, dll.

Features

- Thermometer Digital
- Buzzer for water refill signal.
- Thermostat



JL-T12

JL-T20

TYPE	DIMENSION (cm)		VOLUME (l)	POWER	VOLTAGE	TEMP. (°C)	WEIGHT (kg) Nett Gross
	∅	H					
JL-T12	26	42,5	12	1500	220V/50Hz/1P	30~100 °C	3,1 / 3,9
JL-T20	29	51	20	2200	220V/50Hz/1P	30~100 °C	4,1 / 5,1

Microwave Oven

WITH 2 MAGNETRON



EMB34GTQ

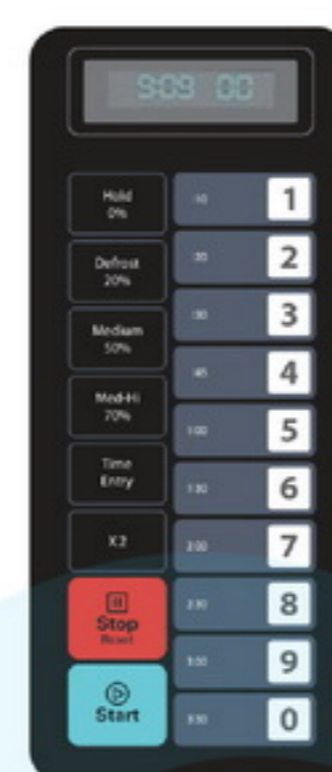

Features

- Digital controller display & touch button
- 4 power levels and 3 cooking stages for different cooking demands
- 10 memory function
- Digital timer
- Magnetron: 2 pcs
- Time entry option and X2, multiple quantity pad provide flexible operation
- Microwave frequency: 2450MHz
- Stainless Steel Air Intake filter for easy cleaning
- Interior light
- Stainless steel body
- Easy to operation
- Stackabel

MODEL	DIMENSION (cm)			CHAMBER SIZE (cm)	CAPACITY (L)	WATT (220V/1P/50Hz)	WEIGHT (Kg) NW/GW
	L	W	H				
EMB34GTQ	57,4	52,8	36,8	34,6x40,8x22,4	34	3200	32,3/34,3





Electric Coffee/Tea Maker

Untuk memasak minuman kopi, teh, dan merebus air panas



CP10

CP15

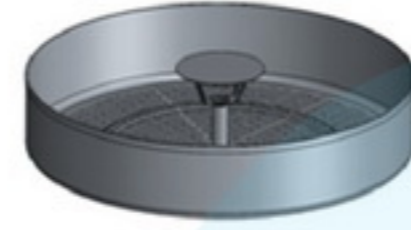

TYPE	DIMENSION (cm)			VOLUME (l)	WATT (220V/1P)
	L	W	H		
CP10	33	33	56	10	1520
CP15	33	33	60	15	1520

Coffee/Tea Warmer

Untuk menghangatkan kopi / minuman teh



CM-0521



DC1.5 DECANTER

TYPE	DIMENSION (cm)			POWER (W)	WEIGHT (kg)
	L	W	H		
CM-0521	39	20	8,5	300/1P	4,5
DC1.5 DECANTER	Ø16		17	-	0,25





Professional Coffee Machine

Espresso & Cappuccino Machine

A unique design based on vintage machines. Strong & beautiful.

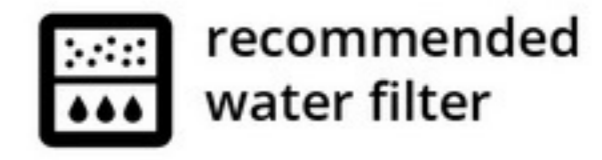

IB7-1GR



IB7-2GR

Features

- Adjustable touch panel settings
- S/S steam pipes, front panel & body
- Anti-splash hot water outlet
- Automatic boiler fill
- Heating element protector
- Internal motor and pump
- Stylish & Back-lit Touch pads
- Filter holder & cup warming grid



IB7-2GR White

Features

- Mono boiler system
- Electronic dosage (4 doses + continuous)
- Volumetric Control
- New touch pad with white leds
- Stainless steel steam wands
- Ergonomic filter-holder
- Automatic boiler refill

TYPE	DIMENSION (cm)			BOILER CAP. (l)	HEATING ELEMENT (W)	STEAM OUTLET	WEIGHT (kg)
	L	W	H				
IB7-1GR	44,5	50,8	46	6	1800 (220V/1P/50Hz)	1	37
IB7-2GR	69,5	50,8	46	10,5	3000 (220V/1P/50Hz)	2	61
IB7-2GR White	69,5	50,8	46	11	3000 (220V/1P/50Hz)	2	55



NEW IBERITAL-2GR

Features

- Single boiler system
- Digital display
- PID electronic temperature control

TYPE	DIMENSION (cm)			BOILER CAPACITY (l)	POWER	VOLTAGE	STEAM OUTLET	WEIGHT (kg)
	L	W	H					
NEW IBERITAL -2GR	78,3	56,8	45,5	14	3800 W	220V/1P/50Hz	2	62





A unique design based on vintage machines. Strong & beautiful.

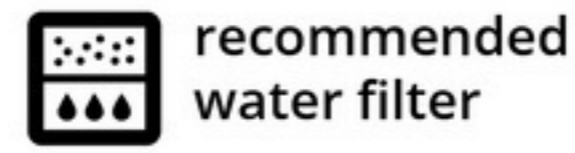

Origin Spain



INTENZ-1GR Black



INTENZ-2GR Black



INTENZ-1GR White



INTENZ-2GR White

Features

- Electronic dosage (four programmable doses + non-stop).
- Automatic boiler water filling.
- Motor and rotary pump pressure.
- Gauge for the pump and boiler pressure.
- Control of temperature safety limit for heating elements.
- Two stainless steel steam dispensers.
- Easy access to the boiler drainage tap.
- Electronic control unit
- With digital display (2GR)

TYPE	DIMENSION (cm)			BOILER CAP. (l)	HEATING ELEMENT	VOLTAGE	STEAM OUTLET	WEIGHT (kg)
	L	W	H					
INTENZ-1GR Black	47,6	58,5	45,1	6,5	1800 W	220V/1P/50Hz	1	42
INTENZ-2GR Black	79	58,5	45,1	11	3000 W	220V/1P/50Hz	2	60
INTENZ-1GR White	47,6	58,5	45,1	6,5	1800 W	220V/1P/50Hz	1	42
INTENZ-2GR White	79	58,5	45,1	11	3000 W	220V/1P/50Hz	2	60





Coffee Grinder

made in Spain



BRASIL



MARFIL TRON INOX



Mesin untuk menggiling kopi seri TRON dengan teknologi terbaru untuk menghasilkan bubuk kopi yang penuh cita rasa. Dilengkapi dengan pisau penggiling berkualitas tinggi, motor penggerak yang handal, dan tombol sentuh LED yang mudah dioperasikan. Cocok untuk digunakan pada hotel, coffee shop, open kitchen, bar, drinks counter & convenience store.

Features

- Speed rpm 1300 ~ 1650
- Adjustment of Coffee Grinding
- Single Mold ABS Bony
- With No Loss of Aroma
- Vibration-free in Unbreakable Material
- Ergonomic Handle
- Universal Coffee Press (rotary)
- Dispenser With Seal-saving System
- Dispenser adjustment: 5 ~ 12 gram
- Maximum continuous service time: 30 Min
- Motor equipped with thermal protector
- Tempered steel grinding wheels, 60mm
- Flat Burrs Blade

- 2 pilihan waktu penggilingan yang dapat disesuaikan
- Fitur manual waktu penggilingan
- Dilengkapi dengan fitur counter, Untuk mengetahui banyaknya proses penggilingan secara berkala

TYPE	DIMENSION (cm)			CAPACITY		WATT (220V/50Hz/1P)	WEIGHT (kg)
	L	W	H	Dispenser	Hoper		
BRASIL	21	35,5	45	300 g	1 kg	275	11
MARFIL TRON INOX	21	35,5	61	600 g	2 kg	352	15

Automatic Milk Frother

made in China

Mesin pembuat busa susu untuk cappucino dengan 3 fungsi :

Bowl capacity
600 ml



JL-NP10



MF-303

- Hot Milk -> heating milk (slightly foam ±80°C)
- Hot and Froth -> heating milk, make milk foam (temperature ±80°C)
- Hot Water -> heating the water

Features

- 6 in 1 Multifunction Induction Heating (Hot milk, cold milk foam (*), hot coffee, hot chocolate, boiling water, warm baby milk)
- Switch (rotary) knob
- Hot frother : Min 100ml, Max 150ml
- Warm frother : Min 100ml, Max 400ml

TYPE	DIMENSION L x W x H (cm)	CAP. (l)	WATT (220V/1P)	GW
JL-NP10	27,5 x 47 x 61,5	10	2200	11 kg

TYPE	DIMENSION Ø x H (cm)	WATT (220V/1P)	NW/GW (Kg)
MF-303	13,5 x 20,5	500	1,3 / 1,6



GETRA[®]

Coffee Machine

bali
coolerswww.balicoolers.com**CLT-Q006****Features**

- One Touch Latte, Cappuccino, Espresso, Coffee, Hot Water, Hot Milk Function
- 3.5" Inch Color Touch Screen Operating Interface
- Double Boiler System for Coffee and Steam Separately
- 19 bar ULKA Pump from Italy
- 4 Languages for selection: German, English, French, Chinese
- 3 levels coffee temperature selection
- Adjustable coffee powder volume and coarseness for every cup coffee
- Removable Milk Tube, Brewing Unit for Easy Maintenance
- Warning Function with language remind all incorrect operations or necessary maintenances
- Milk Frother system self-clean function separately
- LED light for the cup, ON/OFF selection
- Adjustable time to Auto Power-Off, for Energy Saving
- Waste Coffee Tank Capacity : 60 pcs
- Milk Capacity : 600 ml

TYPE	DIMENSION (cm)			CAPACITY		WATT	PUMP PRESSURE	WEIGHT
	L	W	H	Water	Bean	(220V1P)		(kg)
CLT-Q006	54	32	42	2 L	700 g	1350-1500 W	19 bar	13,8

**K90L****Features**

- Dual pump and dual heating system for much higher efficiency
- Large 1 Kg bean container
- Large 6 L water tank
- Integrated big base for coffee grounds and waste water
- Tap water connection
- 3.5" color TFT screen with touch buttons
- Double coffee and milk outlets, and touch for two cups of late
- Multiple cups one time
- Make cappuccino and latte much quicker than you imagine

TYPE	DIMENSION (cm)			CAPACITY		WATT	PUMP PRESSURE	WEIGHT
	L	W	H	Water	Bean	(220V/50Hz/1P)		(kg)
K90L	51,1	39	58,2	6 L	1000 g	2430 W	19 bar	22



GETRA®

Coffee Machine



Mesin pembuat minuman kopi espresso dan cappuccino semi otomatis. Dilengkapi dengan LCD display panel untuk memudahkan pengoperasiannya



SEMI AUTOMATIC



SN-3099

Features

- Stainless steel body (black color)
- Make espresso, coffee and cappuccino
- High speed grinder
- Use connecting rod level to press powder
- Removable Stainless steel handle
- LED light
- Multi-language LCD screen
- Steam function
- Storage water heating to brew the coffee
- Adjustable grind time & degree of coffee powder
- Adjustable coffee volume



SN-3035S

TYPE	DIMENSION (cm)			CAPACITY		WATT (220V/1P/50Hz)	PUMP PRESSURE	WEIGHT Nett / Gross
	L	W	H	W. Tank	Bean			
SN-3099	27,7	41	40,3	3,5 L	250 gr	1300	20 bar	10 / 11,8
SN-3035S	33,6	30	38	1,2 L	-	1160	20 bar	6,4

Mesin untuk membuat minuman black coffee dan kopi espresso secara otomatis. Proses pembuatan minuman secara otomatis dari biji kopi yang digiling hingga proses brewing menghasilkan minuman kopi sesuai selera Anda. Cocok juga digunakan di kantor, ruang meeting, showroom, pantry, dll.



FULL AUTOMATIC



ME-720

Features

- Max cup height 135 mm
- Adjustable grinder with 5 finest level
- Waste drawer capacity : 12 pcs/cycle
- Adjustable coffee bean weight : 10 gr ~ 14 gr
- Removable brewing unit for easy cleaning
- Removable water tank & drip tray
- Water level indicator
- Self-cleaning programmed (rinsing programmed)
- Pump pressure 20 bar



black coffee



espresso

TYPE	DIMENSION (cm)			CAPACITY		WATT 220V/1P/50Hz	TEMP. (°C)	WEIGHT Nett / Gross
	L	W	H	W. Tank	Bean			
ME-720	46,5	22	35,7	1,8 L	250 gr	1450	75 ~ 85	9 / 11





Coffee Machine



SC-7903E

Features

- 3 canester @ 1.6 Kg
- 4 Button kinds of drinks
- Adjustable water temperature (68 ~ 98°C)
- Elegant design & easy operation
- Water supply by gallon or water tap
- Adjustable taste
- Easy cleaning & dismantle
- Large capacity
- Stainless steel frame
- Key lock

TYPE	DIMENSION (cm)			BOILER CAPACITY	RAW BUCKET (gram)	WATT (220V/50Hz/1P)	WEIGHT (kg) Nett Gross
	L	W	H				
SC-7903E	30	38	63	2,7 L	@ 1600 x 3	1600	16,5 / 17,5



SC-71104

Features

- 4 canester @1.6 Kg
- 8 kinds of drinks
- LED display digital control
- Adjustable water temperature (68 ~ 98°C)
- Elegant design & easy operation
- Easy cleaning & easy to dismantle
- Water supply by gallon or water tap
- Sales Counter
- Adjustable drink flavour & mix
- Adjustable water
- Lighted canopy for media promotion
- Depleted water sensor
- Key Lock

TYPE	DIMENSION (cm)			BOILER CAPACITY	RAW BUCKET (gram)	WATT (220V/1P/50Hz)	WEIGHT (kg) Nett Gross
	L	W	H				
SC-71104	33	43,5	67	6 L	@ 1000 x 4	3000	29 / 33

Hot Chocolate Drink Dispenser



CHOC-5

Dispenser khusus untuk aneka minuman / coklat panas
Aplikasi : Coffee shop, Pastry shop, Cafe, dll

Features

- Bain-marie heating prevents product burn
- Thermostat, temperature control as needed
- Anti-clogging of the tap
- Stainless steel boiler, with thermal insulation
- Tray
- Volume meter
- Temperature ~ 80 °C
- Anti-slip feet
- Bowl is easy to clean

TYPE	DIMENSION (cm)			VOLUME (l)	WATT (220V1P/50Hz)	WEIGHT (kg) Nett Gross
	L	W	H			
CHOC-5	41	28	46,5	5	1000	8,8 / 9,2





Chocolate Fountain



Mesin pemancar coklat dari coklat batang yang sudah diencerkan, membentuk air mancur berundak (tersedia 5 susun dan 6 susun). Biasa digunakan untuk penyajian coklat fondue (mencelupkan buah, biskuit, ice cream, kue lapis, manisan buah, ke pancuran coklat).



SC-Q06 Features
• Digital Control

TYPE	DIMENSION (cm)			VOLUME (l)	WATT (220V1P)	TEMP. (°C)	WEIGHT (kg)
	L	W	H				
ET-CF-51	33	33	61,3	3	210 W	30 ~ 60	5,8
SC-Q06	36	36	82	6	280 W	30 ~ 150	8

Chocolate Tempering Machine

Mesin untuk melunakkan/mencairkan coklat agar memudahkan proses pelapisan, pengisian ke roti, pencetakan permen coklat ke dalam mould, dll. Jenis coklat yang digunakan harus disesuaikan untuk mendapatkan hasil terbaik.



TYPE	DIMENSION (cm)			CAPACITY (kg)	HEAER OUTPUT	VOLTAGE	WEIGHT (kg)
	L	W	H				
SG08	43,5	51	48	8	300 W	220V/1P/50Hz	29
SG15	56	60	59	15	500 W		40
SG30	88	65	119	30	1950 W	380V/1P/50Hz	100

*) SG30 sudah dilengkapi meja getar untuk menghindari coklat berongga (isi udara)





Sauce Warmer Machine

Single Head



SWM-1

GETRA Sauce Warmer Machine adalah mesin penghangat topping botol saus, chocolate sauce, sauce keju, black paper sauce, ketchup, karamel, mayonnaise, untuk dijadikan topping / lapisan cake, crepes, wafel, ice cream, dll agar produk mudah melt saat dikeluarkan dan fresh.

Cocok diaplikasikan pada : Cake Shop, Hotel Cafeteria, Cofee Shop, Restoran, Snack Bar, Handmade Chocoolate Shop, dll.



Features

- Material : Body S/s 201
- Bottle material : PE
- Bottle cap. 400 ml
- Thermostat
- Power switch
- Easy to use



Bottle capacity : 400 ml

TYPE	DIMENSION (cm)			BOTTLE		POWER (W)	TEMP. (°C)	VOLTAGE	NW / GW (kg)
	L	W	H	Ø	H				
SWM-1	25	17	23	8	16	80	30 ~ 85	220V/1P/50Hz	2,1 / 3,9

Chocolate/Sugar Coated Machine

Fungsi utama mesin ini :

1. Melapisi film, memberi warna, memoles pada tablet permen / obat
2. Melapisi gula cair pada kacang
3. Melapisi coklat pada kacang (Optional sprayer)

Features

- The pan rotates slowly to flatten out perfect mixing
- Blow hot air before the coating process to speed up the sticking process
- Stainless steel body
- Inclination 15 ~ 45°

Sprayer untuk pelapis

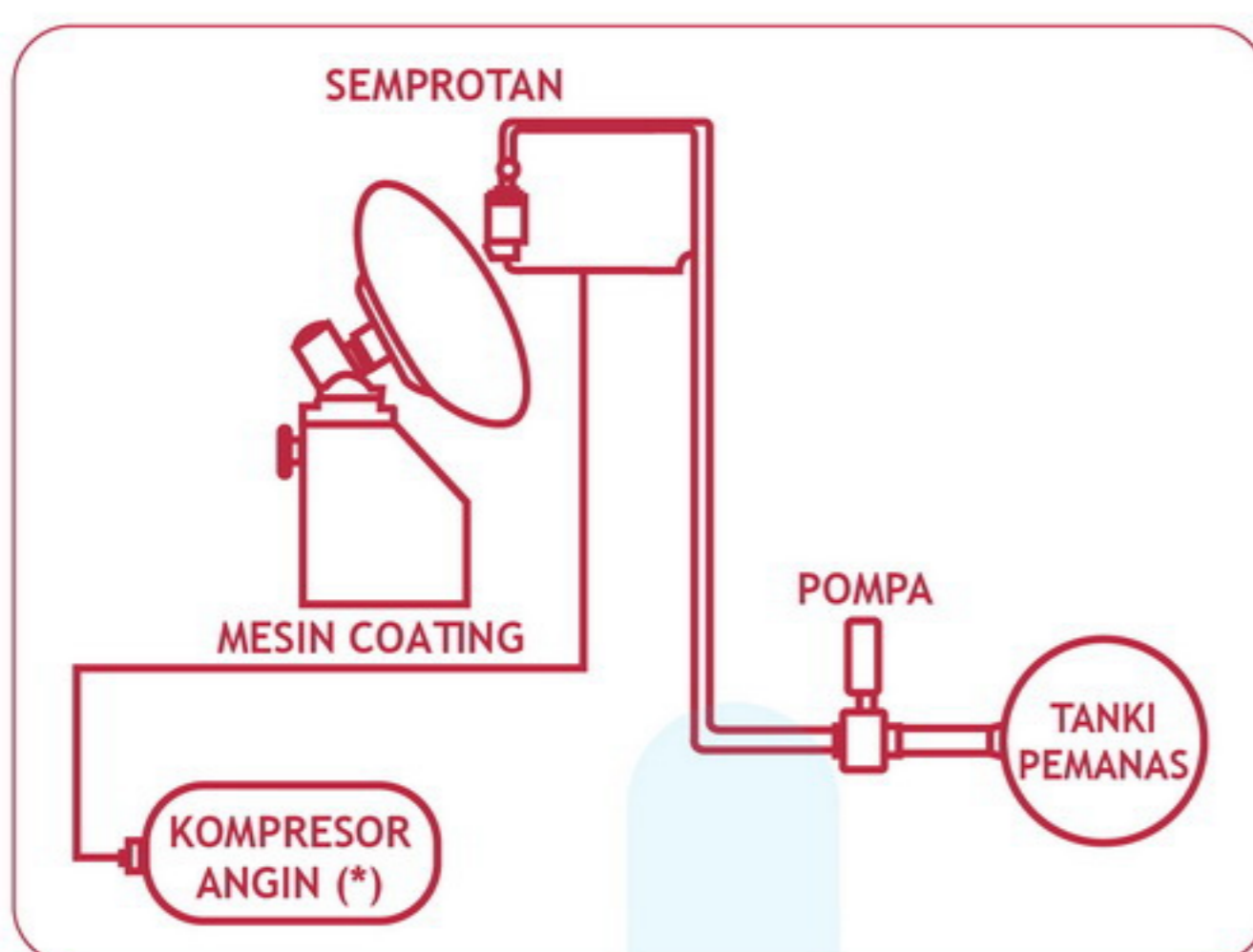

SERI BY

MODEL	DIMENSION (cm)			Ø COATING DRUM (cm)	CAP. (kg/cycle)	SPEED (rpm)	POWER (Watt)			VOLT.	WEIGHT (kg)
	L	W	H				Motor	Fan	Heat		
BY200	60	40	80	20	1	60	120	40	1000	220V/1P	30
BY300	60	40	80	30	2~3	60	120	40	1000	220V/1P	30
BY400	60	40	80	40	5	60	120	40	1000	220V/1P	40
BY600	80	50	100	60	25	45	750	60	1000	380V/3P	75
BY800	100	90	140	80	50	35	1100	120	2x1000	380V/3P	190
BY1000	100	100	150	100	75	30	1100	120	2x1000	380V/3P	200
BY1250	120	140	190	125	100	25	3000	150	2x1500	380V/3P	340
BY1500	180	120	200	150	140	0~20	7500	180	2x1500	380V/3P	800

Sprayer sudah dilengkapi pemanas untuk mencegah penggumpalan coklat

*Prices exclude Air Compressor
* Min. compressor capacity:3HP



GETRA®

Power Mixer

bali
coolers
www.balicoolers.com



Blender tangan multifungsi yang dapat digunakan untuk memproses bahan makanan/ minuman dengan hasil sempurna. Dirancang dengan handle yang ergonomis dan pisau berbahan stainless steel yang mudah dicopot untuk dibersihkan. Cocok untuk mengaduk adonan es krim, bakery, membuat juice, dll.



**IB350CV
IB500LV**

MIXER TUBE

MIXER WHISK

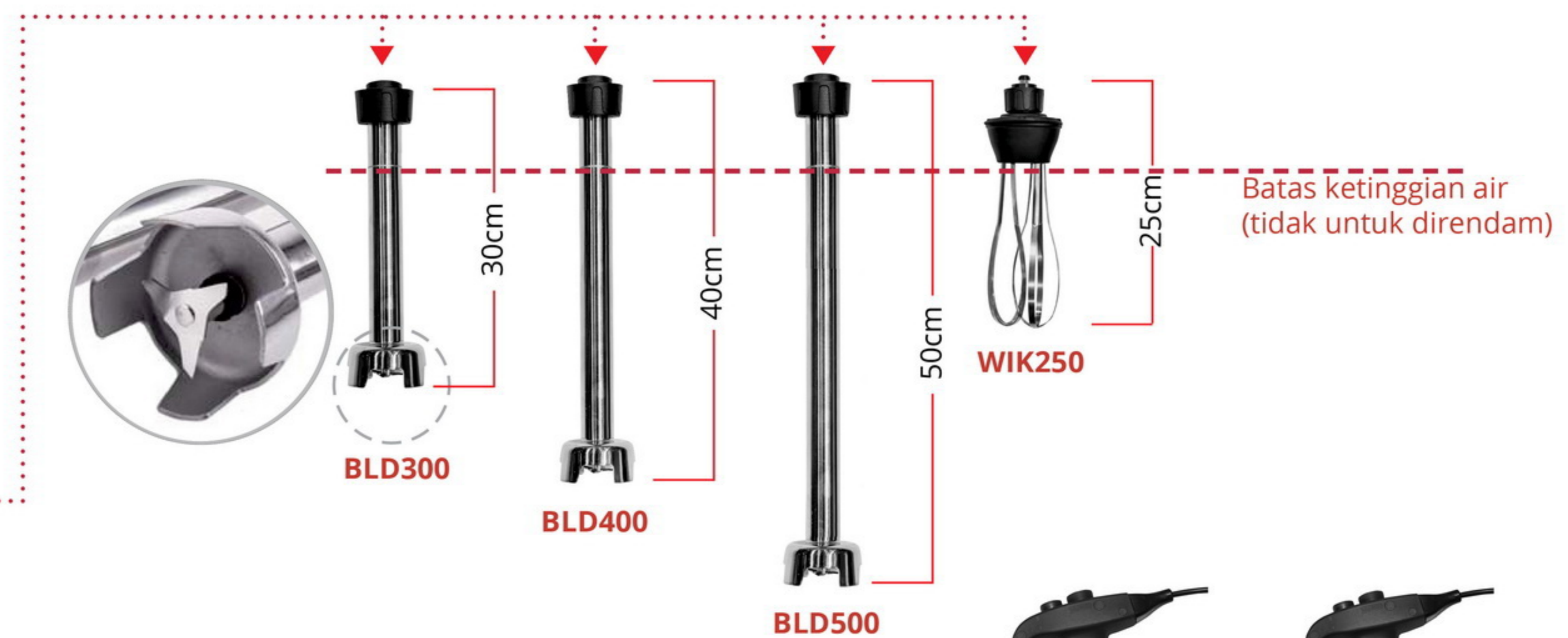

TYPE	DIMENSION (cm)		VARIABLE SPEED (rpm)	POWER (220V/1P/50Hz)	WEIGHT (kg)		INFORMATION
	Ø	H			Nett	Gross	
IB350CV	9,1	35,9	4000 ~ 16000	350 W	1,3	1,76	Power Mixer
IB500LV	9,1	35,9	4000 ~ 16000	500 W	1,4	1,98	
BLD300	3,5	30	-	-	1,02	1,3	Mixer Tube
BLD400	3,5	40	-	-	1,28	1,48	
BLD500	3,5	50	-	-	1,56	1,76	
WIK250	-	25	-	-	0,86	1,2	Mixer Whisk

Harga power mixer belum termasuk mixer tube/whisk



GETRA®

Syrup Dispenser

bali
coolers

www.balicoolers.com



GT06

Features

- Black stainless steel body
- Silver stainless steel tank
- Control panel
- On/off switch button
- 16 memories



TYPE	DIMENSION (cm)			WATT	VOLUME (l)	VOLTAGE	WEIGHT (kg)
	L	W	H				
GT06	35,5	25	44,2	400	6	220V/1P/50Hz	5,8

Boba Machine

Full Automatic Boba Machine

Ball / boba size \varnothing 8mm



CLZ-40

Semi Automatic Boba Machine

Ball / boba size \varnothing 8mm



CLZ-18S

TYPE	DIMENSION (cm)			CAPACITY (kg/hour)	POWER	VOLTAGE	WEIGHT (kg)
	L	W	H				
CLZ-40	63	31	47	5-12	1200 W	220V/50Hz	60
CLZ-18S	47	45	56	5-15	400 W	220V/50Hz	34.5





Dumpling Maker

Semi-Automatic Table Type

Membuat dumpling dengan isian (filling) pada hopper. Cocok untuk membuat : Kuotie Ayam, Jiaozi, Dimsum, Gyoza. Mesin berukuran portable ini bekerja secara semi otomatis dengan kapasitas produksi hingga 1500 pcs tiap jam.



Simple Operation



Features

- Material : Stainless steel, aluminium alloy
- Conveyor belt
- Operation button
- Knob ON/OFF & Light indicator
- Hopper height 22cm

Gyoza optional size (*)

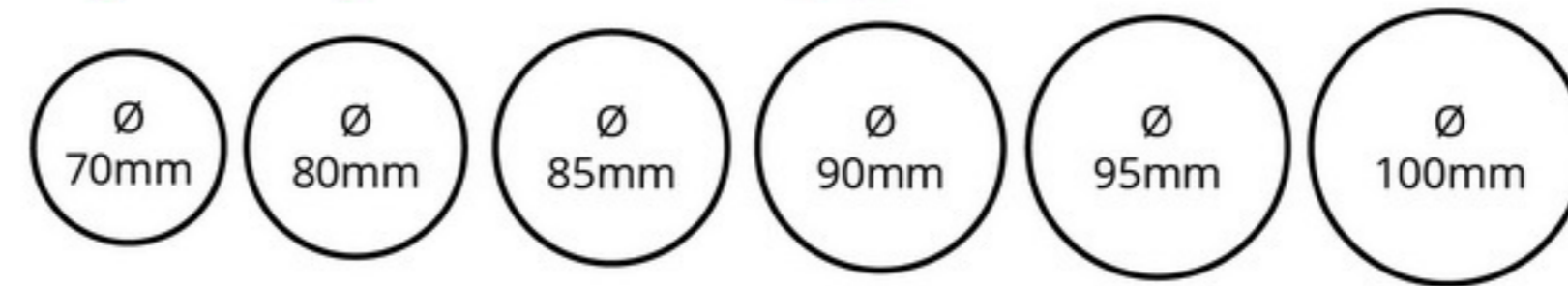

Skin Ø	Skin Weight	Filling Weight	Weight
70mm	6gr	9gr	15gr
80mm	8gr	12gr	20gr
85mm	9gr	13gr	22gr
90mm	9/10gr	14gr	24gr
95mm	13gr	17gr	30gr
100mm	11gr	22gr	33gr

(*) Untuk pemesanan unit dengan ukuran optional dapat dilakukan indent (1 ukuran untuk setiap mesin)

DR-JZ1D

Skin Ø	Skin Weight	Filling Weight	Weight
75mm	7gr	11gr	18gr

Gyoza skin standard size

*) Berat pada tabel adalah ilustrasi, berat sesungguhnya tergantung pada adonan

TYPE	DIMENSION (cm)			HOPPER HEIGHT (cm)	CAPACITY (pcs/hour)	POWER (Watt)	VOLTAGE	WEIGHT (kg)
	L	W	H					
DR-JZ1D	35	37	48	22	1500	900	220V/1P/50Hz	45

Mesin untuk membuat kulit dumpling (gyoza) secara otomatis, memproses adonan dumpling menjadi kulit dengan diameter bisa diatur (ukuran standar 8cm). Mampu memproduksi kulit dumpling 60 pcs/menit

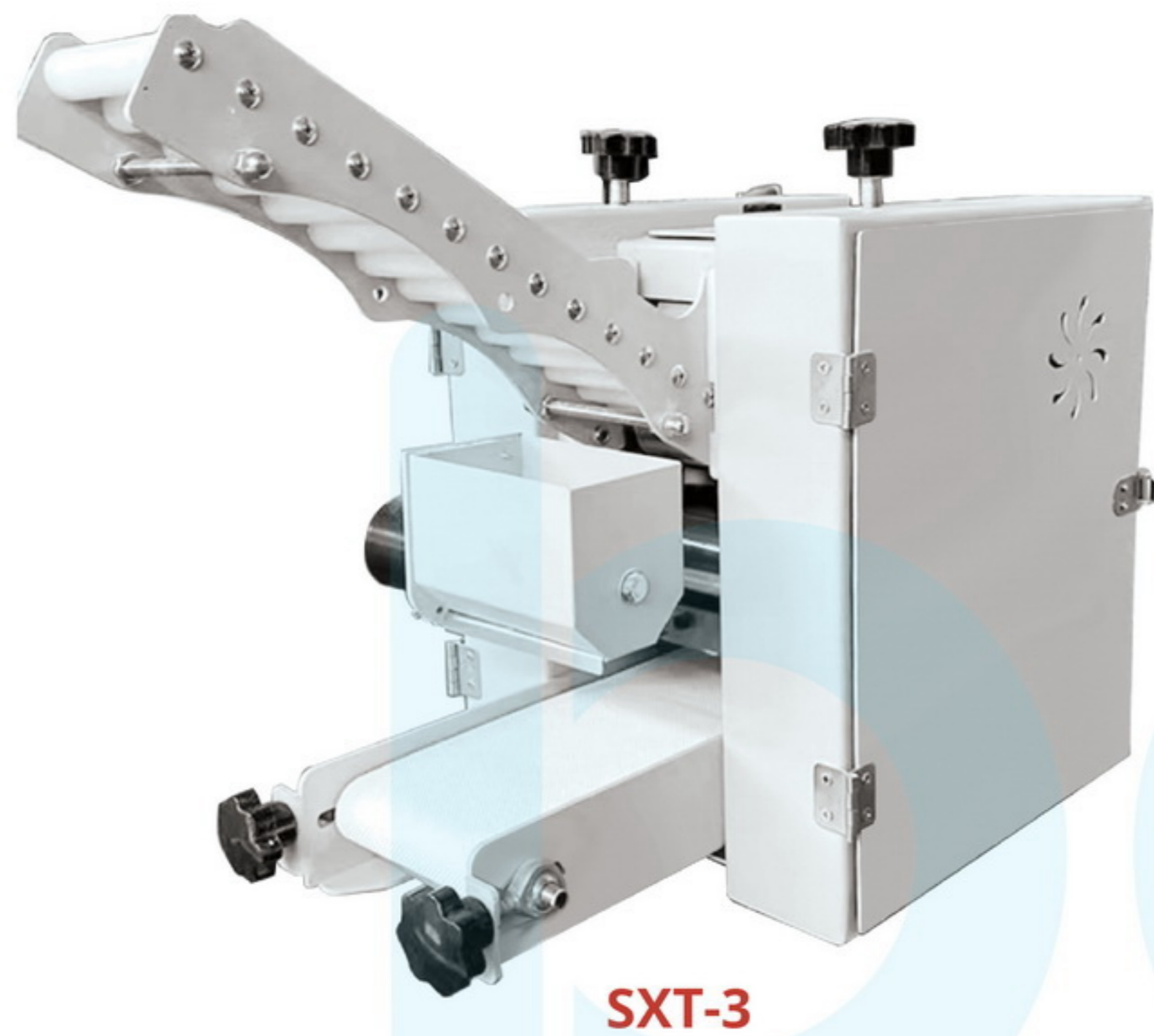

Features

- Dumpling skin size can be customized, the regular size is 80mm
- Adjusting handle/knob
- Powder bucket



TYPE	DIMENSION (cm)			CAPACITY (pcs/min)	POWER (Watt)	VOLTAGE	WEIGHT (NW/GW (kg))
	L	W	H				
SXT-3	52	32	47	60	2500	220V/1P/50Hz	60 / 65



